

**ASSEMBLY INSTRUCTIONS**  
**COMFORT SERIES**  
**MULTI-FUNCTION TASK CHAIR**  
**MODEL NO. 4021**

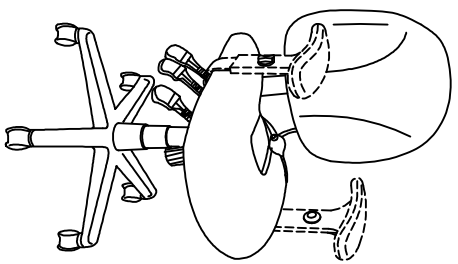









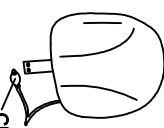

Shown with Optional Arms

**PARTS LIST 4021**

When ordering components, specific color and/or size information may be required.  
 Contact a Mayline Customer Service Representative. 1-800-822-8037

\* Individual Items, Order by part number.  
 \*\* Denotes Color Code

<b>A *</b> Reference Letter	 Part Number <b>CM404** Back</b> Lumbar Bulb CM366*	<b>1</b>	Quantity
<b>B *</b> Reference Letter	 Part Number <b>CM414** Seat</b> Lumbar Holster CM367*	<b>1</b>	Quantity
<b>C *</b> Reference Letter	 Part Number <b>CM421 Mechanism</b>	<b>1</b>	Quantity
<b>D *</b> Reference Letter	 Part Number <b>CM210 Caster (5 pack)</b>	<b>5</b>	Quantity
<b>E *</b> Reference Letter	 Part Number <b>CM440 Base</b>	<b>1</b>	Quantity
<b>F *</b> Reference Letter	 Part Number <b>CM431 Cylinder</b>	<b>1</b>	Quantity
<b>G *</b> Reference Letter	 Part Number <b>CM350 Cylinder Cover</b>	<b>1</b>	Quantity

<b>Part Number</b> <b>CM452 * Hardware Pack</b>			
<b>H</b> Reference Letter	 Screw M8 X 22mm	<b>4</b>	Quantity
<b>J</b> Reference Letter	 Screw M8 X 32mm	<b>2</b>	Quantity
<b>K</b> Reference Letter	 Allen Wrench	<b>1</b>	Quantity
		<b>1</b>	Spare

**IMPORTANT!**  
**Review ALL instructions before beginning assembly.** These instructions are provided to avoid problems that may occur from improper assembly or installation. Mayline and/or its distributor are not responsible for failure resulting from improper assembly or installation of this product. Moreover, all warranties are void for failure to follow these assembly instructions.



© Mayline Company, LLC  
 619 N. Commerce, P.O. Box 728  
 Sheboygan, WI 53082-0728  
 Toll Free: 1-800-822-8037  
 FAX: 920-457-7388  
 On Line: www.mayline.com

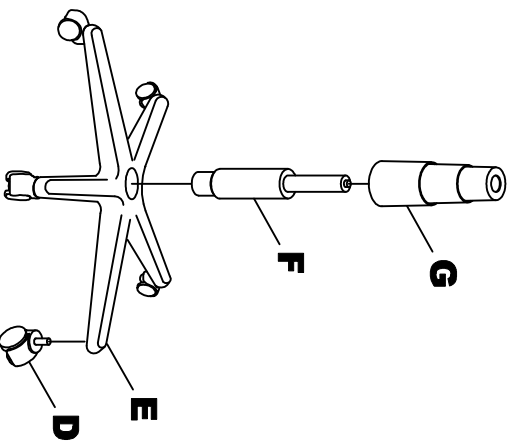

1. Place Base (E) upside down and push Casters (D) firmly into base. 5 places.
2. Turn Base right side up and insert Cylinder (F) into center hole of Base.
3. Place Cylinder Cover (G) over Cylinder.

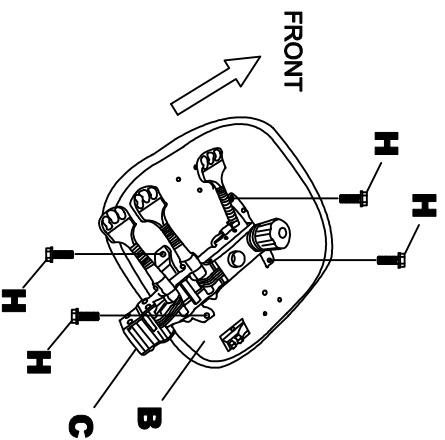

4. Assemble Mechanism (C) to Seat (B) using Screws (H) 4 places.

(3)

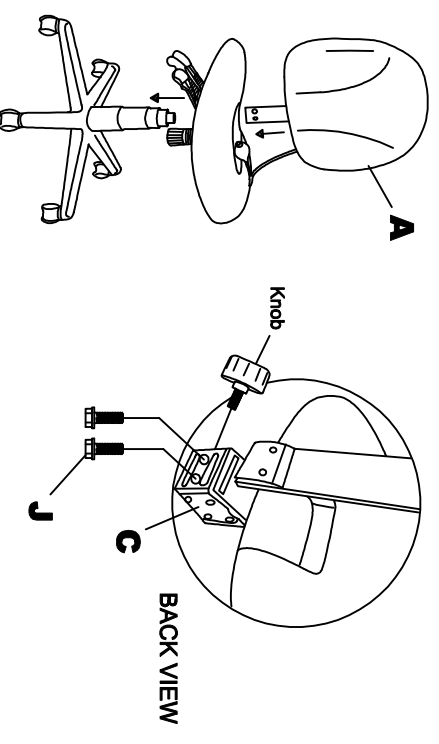

5. Carefully place seat assembly onto base assembly.
6. Assemble Back (A) to Mechanism (C) using Screws (J) 2 places. May have to loosen Knob.

**NOTE:**  
Periodically (Every 90 days) make sure all screws are fully tightened.

(4)

**OPERATING INSTRUCTIONS FOR  
MULTI-FUNCTION MECHANISM & CHAIR FEATURES.**

**1. Back Posture Adjustment**

To adjust angle of the back, pull paddle up.  
Adjust back, push knob down to lock.

**2. Seat Posture Adjustment**

To adjust angle of the seat, pull paddle up.  
Adjust seat, push knob down to lock.

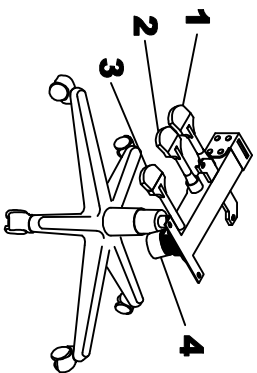

**3. Seat Height Adjustment.**

To raise the seat, pull lever upward and raise your body up slightly to allow the chair to rise to the desired height.

To lower the seat, pull lever upward and apply weight downward on the seat.

**4. Tilt Tension Control Knob.**

Turn knob clockwise to increase tilt tension.

Turn knob counter-clockwise to decrease tilt tension.

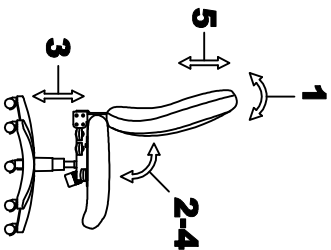

**5. Ratcheting Back Height Adjustment.**

To raise the back, Lift up to the desired height.

To lower the back, Lift up to the upmost position and lower to starting position. Lift up to the desired height.