

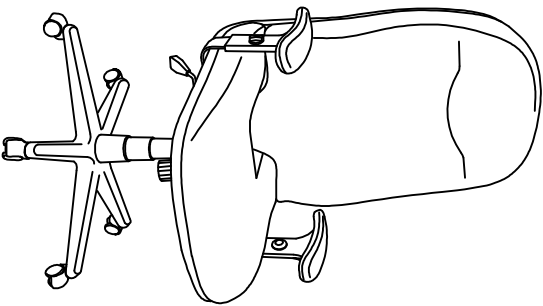





**ASSEMBLY INSTRUCTIONS**  
**COMFORT SERIES**  
**EXECUTIVE HIGH-BACK CHAIR (FABRIC)**  
**MODEL NO. 9413AG**

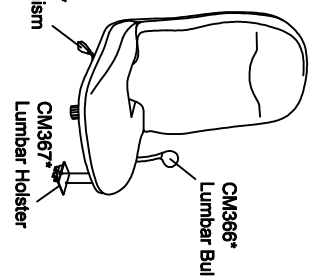
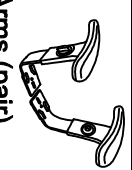

**PARTS LIST 9413AG**

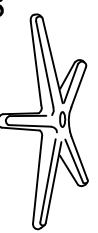
When ordering components, specific color and/or size information may be required.  
 Contact a Mayline Customer Service Representative. 1-800-822-8037

\* Individual Items, Order by part number.  
 \*\* Denotes Color Code

Reference Letter <b>A</b> *		Quantity <b>1</b>
Part Number <b>CM400** Back/Seat</b>		
Reference Letter <b>B</b> *		Quantity <b>1</b>
Part Number <b>12ADJARM Arms (pair)</b>		
Reference Letter <b>C</b> *		Quantity <b>5</b>
Part Number <b>CM210 Caster (5 pack)</b>		
Reference Letter <b>D</b> *		Quantity <b>1</b>
Part Number <b>CM440 Base</b>		
Reference Letter <b>E</b> *		Quantity <b>1</b>
Part Number <b>CM186 Cylinder</b>		
Reference Letter <b>F</b> *		Quantity <b>1</b>
Part Number <b>CM350 Cylinder Cover</b>		
Part Number <b>CM450* Hardware Pack</b>		
Reference Letter <b>G</b>		Quantity <b>6</b>
Reference Letter <b>H</b>		Quantity <b>1</b>
		Spare <b>1</b>

**IMPORTANT!**  
**Review ALL instructions before beginning assembly.** These instructions are provided to avoid problems that may occur from improper assembly or installation. Mayline and/or its distributor are not responsible for failure resulting from improper assembly or installation of this product. Moreover, all warranties are void for failure to follow these assembly instructions.

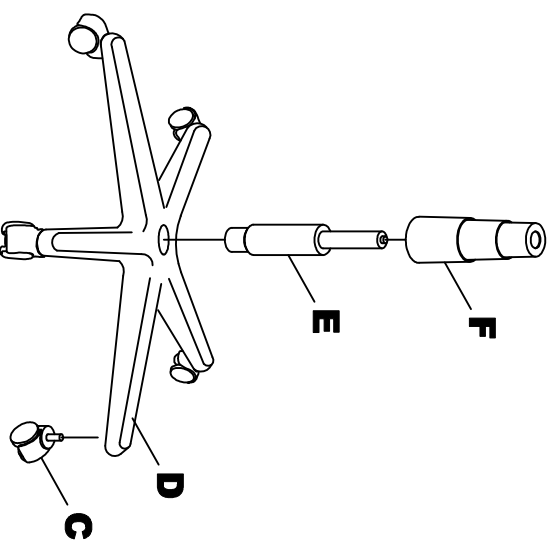

1. Place Base (D) upside down and push Casters (C) firmly into base. 5 places.
2. Turn Base right side up and insert Cylinder (E) into center hole of Base.
3. Place Cylinder Cover (F) over Cylinder.

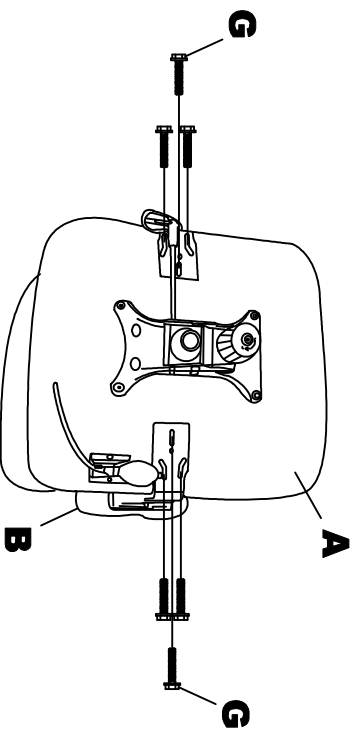

4. Assemble Arms (B) 2 places onto BackSeat (A) using Screws (G) 6 places.

(3)

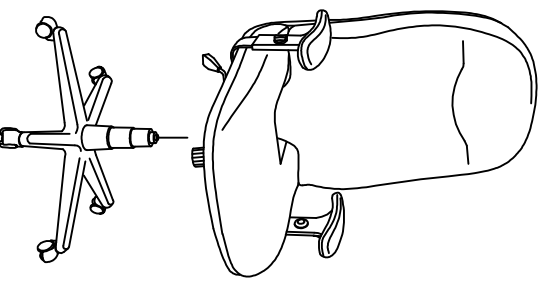

5. Carefully place chair assembly onto base assembly.

**NOTE:**  
Periodically (Every 90 days) make sure screws are fully tightened.

**OPERATING INSTRUCTIONS FOR CENTER PIVOT MECHANISM**

**1. Seat Height Adjustment.**

To raise the seat, rotate lever upward and raise your body up slightly to allow the chair to rise to the desired height.  
To lower the seat, rotate lever upward and apply weight downward on the seat.

**Seat Upright Lock.**

To lock chair in upright position, lean forward and push knob toward chair.  
To unlock chair in upright position, lean forward and pull away from chair.

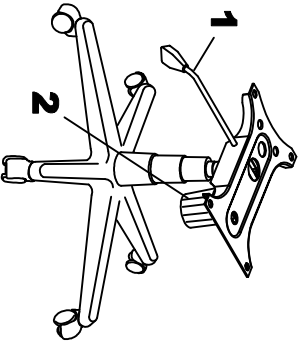

**2. Tilt Tension Control Knob.**

Turn knob clockwise to increase tilt tension.  
Turn knob counter-clockwise to decrease tilt tension.

(4)