

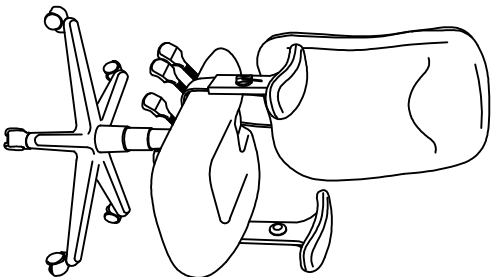











**ASSEMBLY INSTRUCTIONS**  
**COMFORT SERIES**  
**EXECUTIVE POSTURE CHAIR (FABRIC)**  
**MODEL NO. 9414AG**

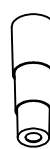

**PARTS LIST 9414AG**

When ordering components, specific color and/or size information may be required.  
 Contact a Mayline Customer Service Representative. 1-800-822-8037

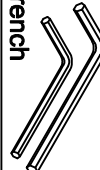
\* Individual Items. Order by part number.  
 \*\* Denotes Color Code

Reference Letter <b>A</b> *	Quantity <b>1</b>	Part Number <b>CM402** Back</b> Lumber Bulb CM366*	
Reference Letter <b>B</b> *	Quantity <b>1</b>	Part Number <b>CM412** Seat</b> Lumber Holster CM367*	
Reference Letter <b>C</b> *	Quantity <b>1</b>	Part Number <b>12ADJARM Arms (Pair)</b>	
Reference Letter <b>D</b> *	Quantity <b>1</b>	Part Number <b>CM421 Mechanism</b>	
Reference Letter <b>E</b> *	Quantity <b>5</b>	Part Number <b>CM210 Castor (5 pack)</b>	
Reference Letter <b>F</b> *	Quantity <b>1</b>	Part Number <b>CM440 Base</b>	
Reference Letter <b>G</b> *	Quantity <b>1</b>	Part Number <b>CM431 Cylinder</b>	
Reference Letter <b>H</b> *	Quantity <b>1</b>	Part Number <b>CM350 Cylinder Cover</b>	
Part Number <b>CM453 * Hardware Pack</b>	Quantity <b>4</b>	Reference Letter <b>J</b>	
Reference Letter <b>K</b>	Quantity <b>2</b>	Reference Letter <b>L</b>	
Reference Letter <b>M</b>	Quantity <b>2</b>	Reference Letter <b>N</b>	
Reference Letter <b>O</b>	Quantity <b>1</b>	Reference Letter <b>P</b>	

**IMPORTANT!**  
 Review **ALL instructions before beginning assembly**. These instructions are provided to avoid problems that may occur from improper assembly or installation. Mayline and/or its distributor are not responsible for failure resulting from improper assembly or installation of this product. Moreover, all warranties are void for failure to follow these assembly instructions.



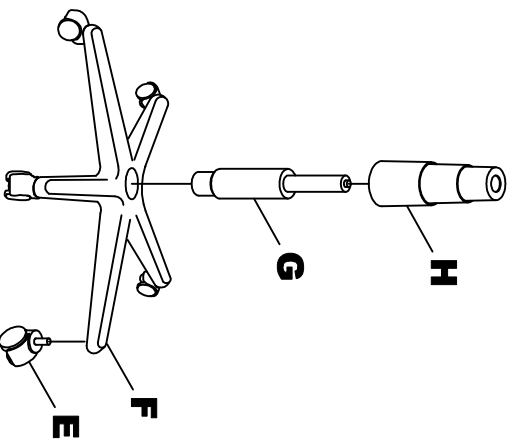

1. Place Base (F) upside down and push Casters (E) firmly into base. 5 places.
2. Turn Base right side up and insert Cylinder (G) into center hole of Base.
3. Place Cylinder Cover (H) over Cylinder.

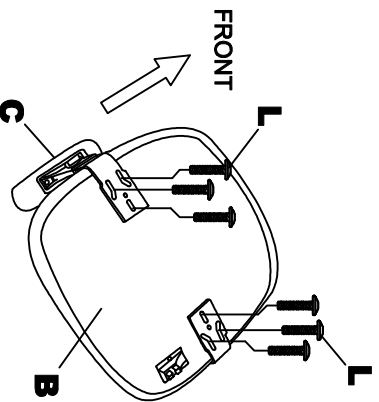

4. Assemble Arms (C) 2 places onto Seat (B) using Screws (L) 6 places.

(3)

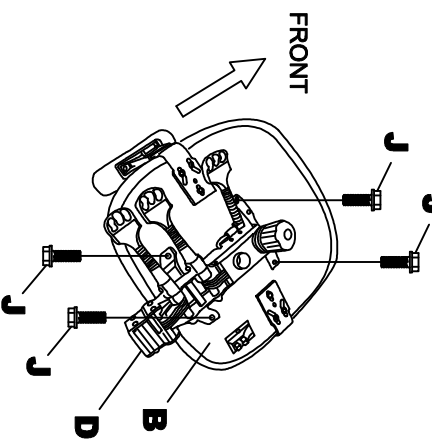

5. Assemble Mechanism (D) to Seat (B) using Screws (J) 4 places.

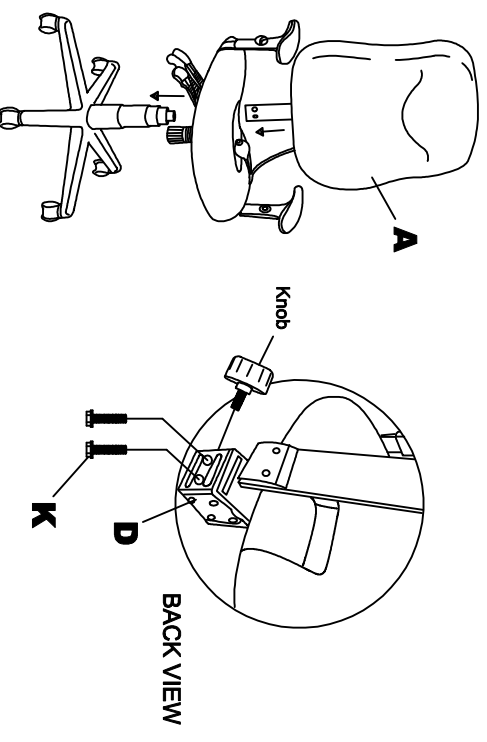

6. Carefully place seat assembly onto base assembly.
7. Assemble Back (A) to Mechanism (D) using Screws (K) 2 places. May have to loosen Knob.

**NOTE:**  
Periodically (Every 90 days) make sure all screws are fully tightened.

(4)

**OPERATING INSTRUCTIONS FOR  
MULTI-FUNCTION MECHANISM & CHAIR FEATURES.**

**1. Back Posture Adjustment**

To adjust angle of the back, pull paddle up.  
Adjust back, push knob down to lock.

**2. Seat Posture Adjustment**

To adjust angle of the seat, pull paddle up.  
Adjust seat, push knob down to lock.

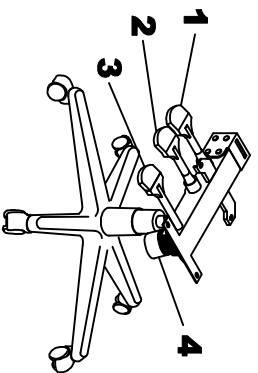

**3. Seat Height Adjustment.**

To raise the seat, pull lever upward and raise your body up slightly to allow the chair to rise to the desired height.

To lower the seat, pull lever upward and apply weight downward on the seat.

**4. Tilt Tension Control Knob.**

Turn knob clockwise to increase tilt tension.

Turn knob counter-clockwise to decrease tilt tension.

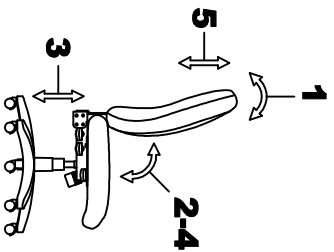

**5. Ratcheting Back Height Adjustment.**

To raise the back, Lift up to the desired height.

To lower the back, Lift up to the upmost position and lower to starting position. Lift up to the desired height.