

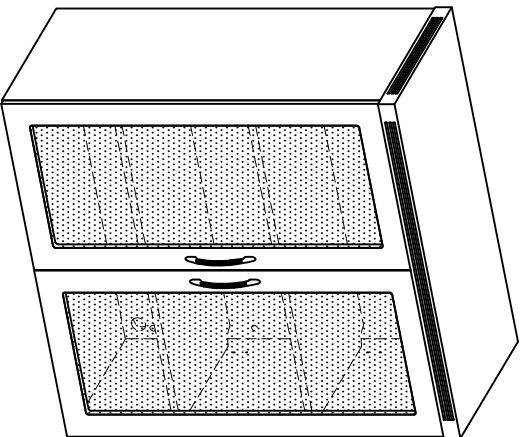







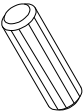

Aberdeen Series™
Glass Display Cabinet
Model No. AGDC



ASSEMBLY INSTRUCTIONS







CALL 1-800-822-8037 FOR ASSISTANCE

PARTS LIST

Name	Part	Qty.	Spare Qty	Name	Part	Qty.	Spare Qty
A	REALS004 Wood Dowel 	16	2	G	REALS104 Black Grommet 35mm 	2	
B	REALS003 Cain Post 	18	2	H	REALS204 Foam Tape 	2	
C	REALS001 Cain Fastener 	18	2	J	REALS025 Door Stop 	1	
D	REALS102** Cain Sticker 	18	2	K	REALS017 Ø3.5 x 16mm 	2	
E	REALS009 Shelf Support Pin 	8	1		AGDC 		
F	REALS191 Handle w/ Screws 	2					

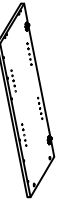
Items with HB are in hardware box.
**Denotes Color Code

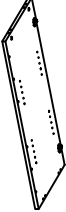
PARTS LIST

Name	Part	Qty.	Name	Part	Qty.
N*	 AGDCN** Top	1	S	 AGDCS** Bottom	1
P	 AGDCP** Right Side Panel	1	T	 AGDCT** Moveable Shelf	2
Q	 AGDCQ** Left Side Panel	1	U*	 AGDCU** Glass Doors	2
R	 AGDCR** Back Panel	1			

* Available in Cherry (LCR) or Mocha (LDC) finish only.

**Denotes Color Code

2

1

Attach Door Stop (J) to Top (N) using Screws (K).

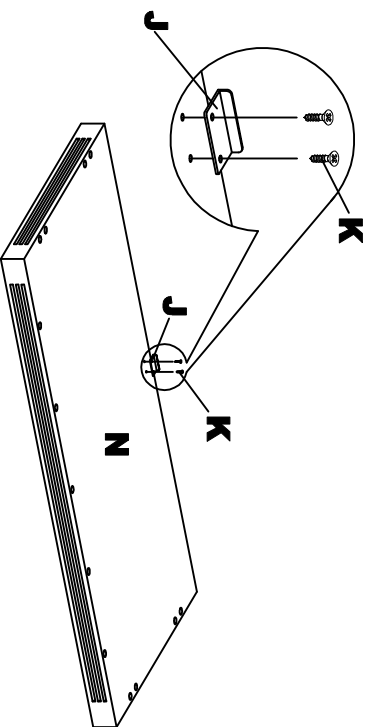

3

2

Insert Wood Dowels (A) into Bottom (S). Insert Cambs (C) into Bottom (S). Install Cam Posts (B) into threaded inserts in Back Panel (R). Attach Bottom (S) to Back Panel (R) by turning Cambs (C).

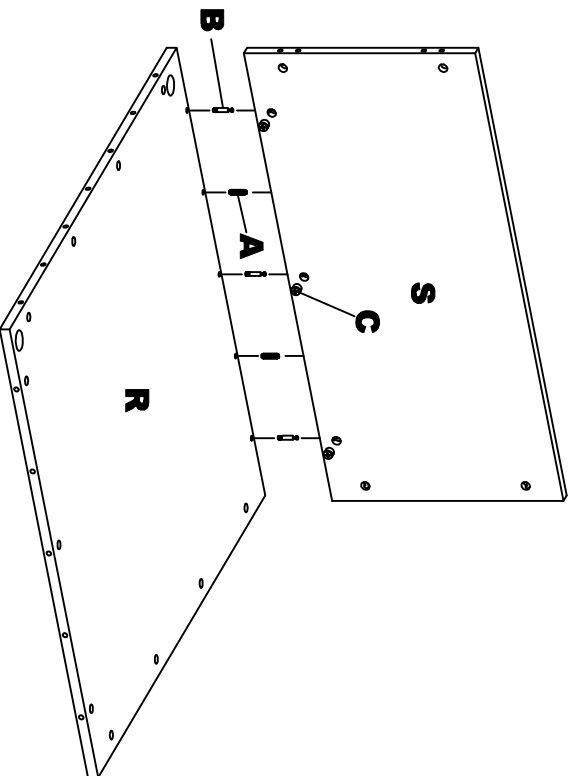

NOTE: The arrow on the face of the Cam (C) should point towards the Cam Post (B) for proper alignment.

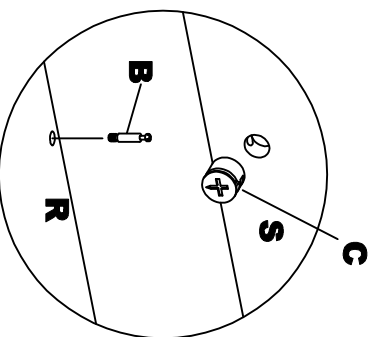

4

3

Insert Wood Dowels (A) into Back Panel (R) and in Bottom (S). Insert Cambs (C) into Back Panel (R) and in Bottom (S). Install Cam Posts (B) into threaded inserts in Side Panels (P & Q). Attach Side Panels (P & Q) to Back Panel (R) and Bottom (S) by turning Cambs (C).

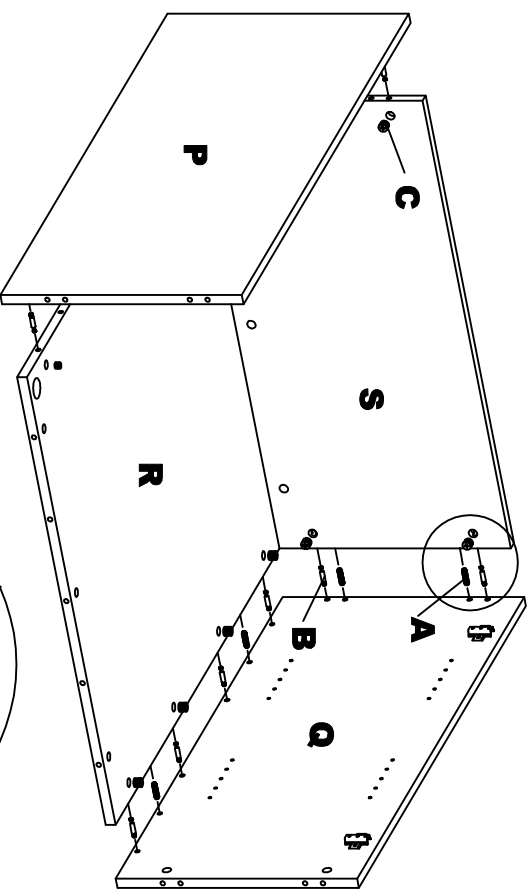

NOTE: The arrow on the face of the Cam (C) should point towards the Cam Post (B) for proper alignment.

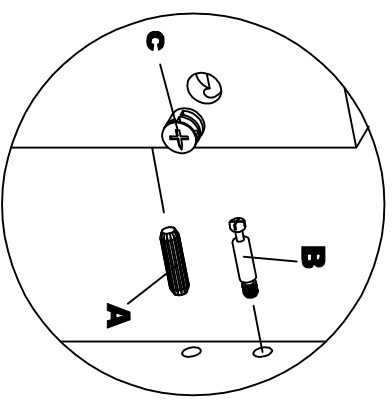

5

4

Insert Wood Dowels (A) into tops of Back Panel (R) and Side Panels (P & Q). Insert Cambs (C) into Back Panel (R) and Side Panels (P & Q). Install Cam Posts (B) into threaded inserts in Top (N). Attach Top (N) to Back Panel (R) and Side Panels (P & Q) by turning Cambs (C).

Apply Foam Tape (H) to bottom edge of Left and Right Side Panel (P & Q) and Back Panel (R).

Apply Cam Stickers (D) over exposed Cambs (C).

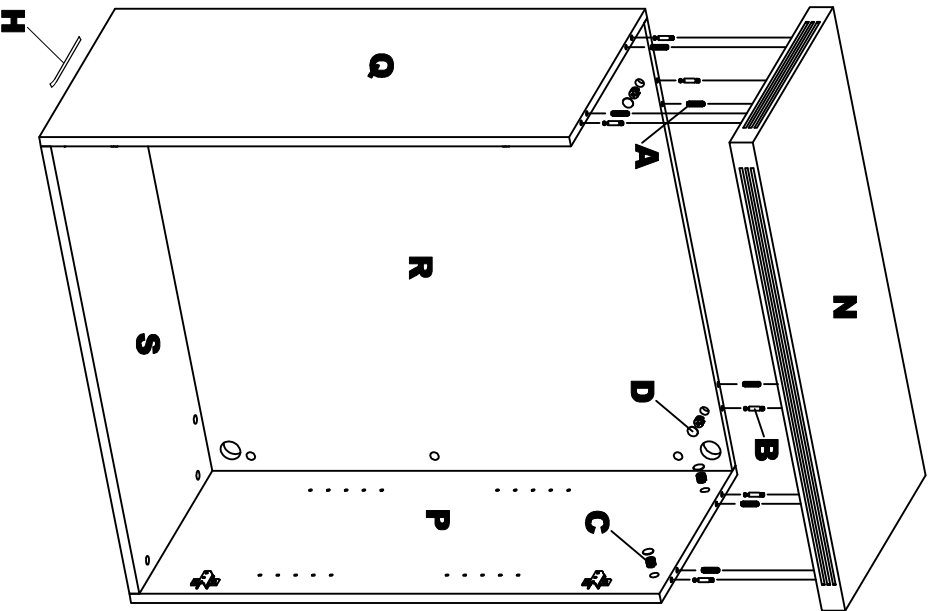

6

5

Install Grommets (G) into Back Panel (R).

Install Shelf Support Pins (E) into Left and Right Side Panel (P & Q). Install Moveable Shelves (T).

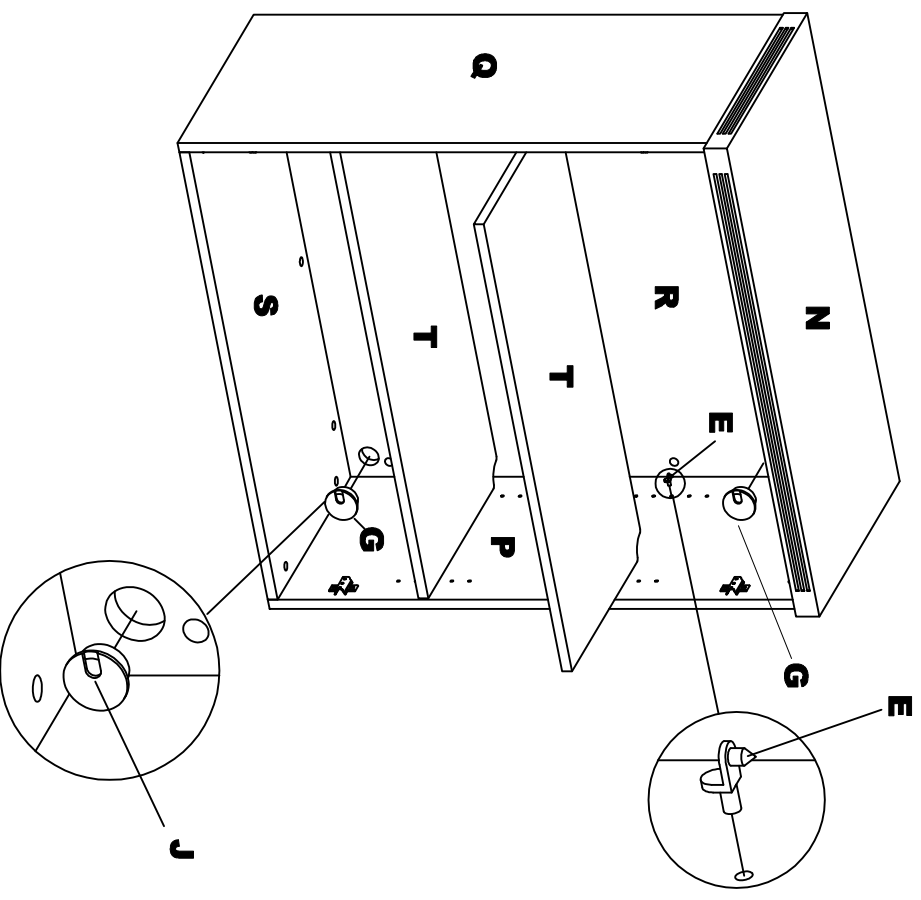

7



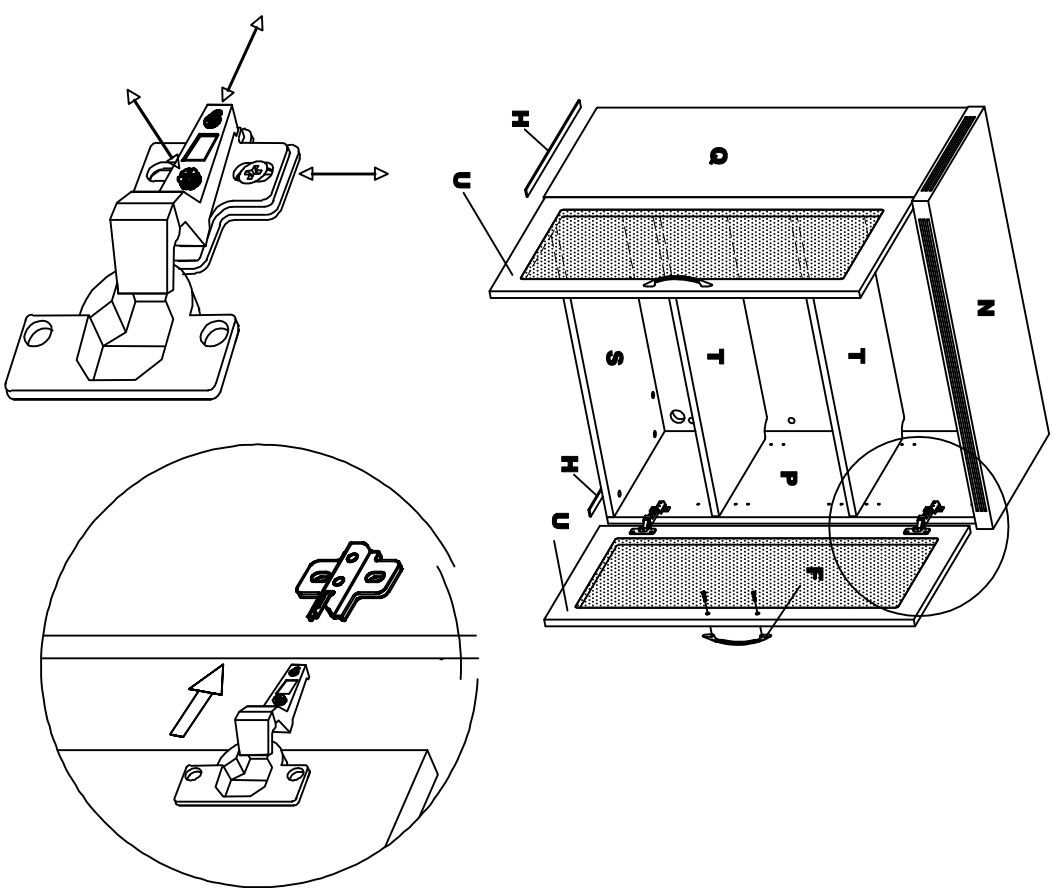

6 Attach Handles (F) to Glass Doors (U) using screws supplied with Handle. Install Glass Doors (U) onto cabinet.

Adjust doors for alignment as necessary by using the adjustment screws on the hinges. DO NOT use Power Driver to make these adjustments.



8

Pre-Installed Replacement Parts List

Part	Included Qty.	Part	Included Qty.
 REALS013 Hinge - Straight	4	 REALS013P Hinge Plate - Short	4
 REALS247 Bumper	2	 REALS018 Ø4 x 14mm	16

9