

Aberdeen Series™

Hutch with Glass Doors

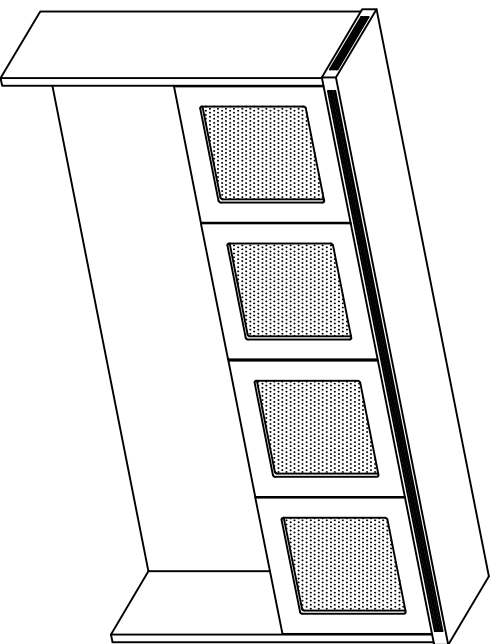







Model No. AHG72, AHG66 & AHG60



ASSEMBLY INSTRUCTIONS

CALL 1-800-822-8037 FOR ASSISTANCE







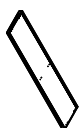

PARTS LIST

| Name | Part | Qty. | Spare Qty. | Name | Part | Qty. | Spare Qty. |
|----------|---|------|------------|----------|---|------|------------|
| A |  REALS004 Wood Dowel HB | 20 | 1 | E |  REALS238 Ø4 x 14mm HB | 4 | 1 |
| B |  REALS003 Cam Post HB | 20 | 1 | F |  REALS104 Grommet HB | 4 | |
| C |  REALS001 Cam Fastener HB | 20 | 1 | G |  REALS506 Plate HB | 2 | |
| D |  REALS102** Cam Sticker HB | 20 | 1 | |  AHHB | | |

Items with HB are in hardware box.

**Denotes Color Code

PARTS LIST

| Name | Part | Qty. | Name | Part | Qty. |
|-----------|--|------|-----------|--|------|
| L* |  AH~L** Top Shelf | 1 | R |  AH~R** Lower Back Panel | 1 |
| M |  AH~M** Shelf | 1 | S |  AHS** Center Divider | 1 |
| N |  AHN** Left Side Panel | 1 | T* |  AHG~T** Right Side Door | 2 |
| P |  AHP** Right Side Panel | 1 | U* |  AHG~U** Left Side Door | 2 |
| Q |  AH~Q** Upper Back Panel | 1 | | | |

* Available in Cherry (LCR) or Mocha (LDC) finish only.

** Denotes Color Code

~ Denotes Size (72, 66, 60)

2

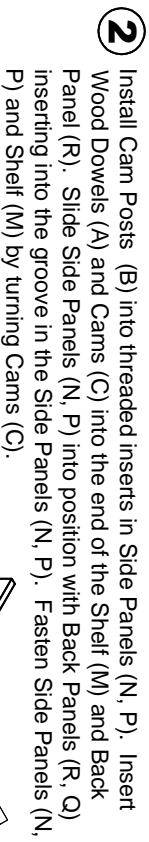
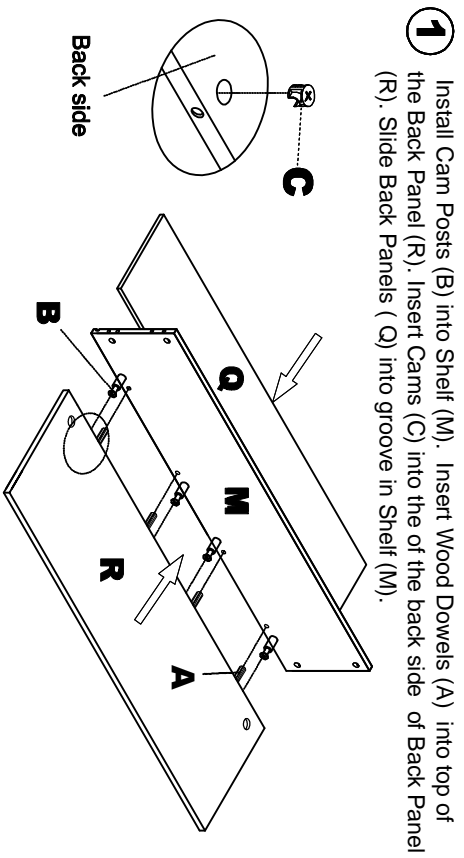

NOTE: The arrow on the face of the Cam (C) should point towards the Cam Post (B) for proper alignment.

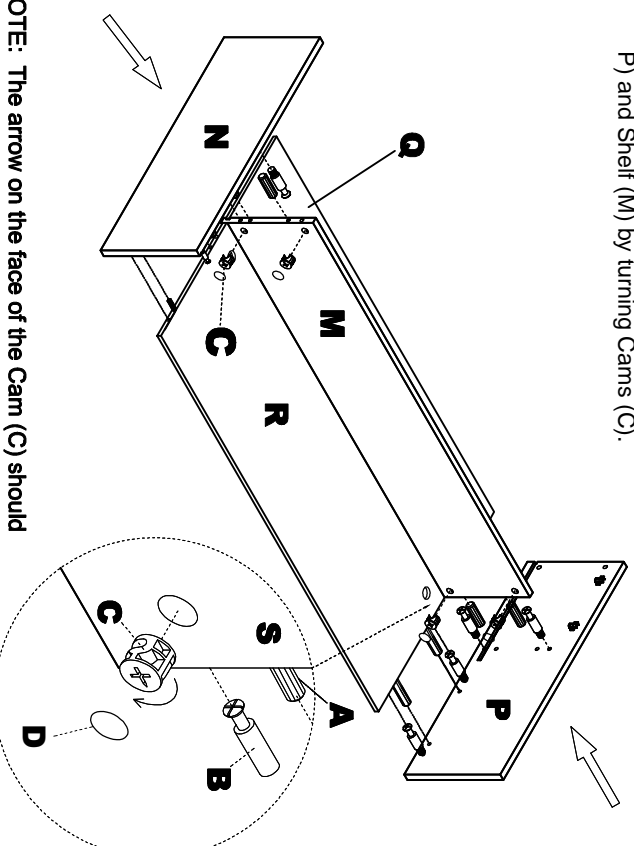

3

3

Stand unit in upright position. Install Cam Posts (B) into Shelf (M). Insert Dowels (A) and Cam (C) into the Center Divider (S). Fasten Center Divider (S) to Shelf (M) by turning Cam (C).

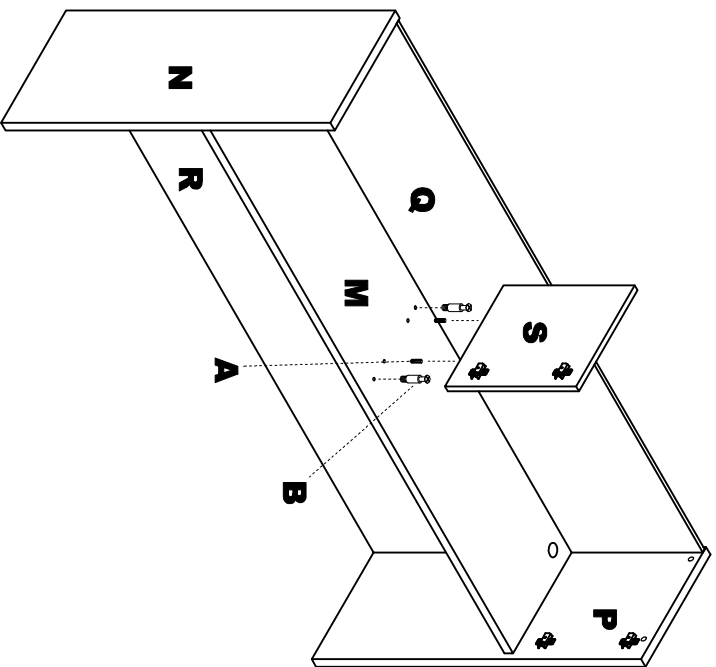

4

4

Install Cam Posts (B) into threaded Inserts in the Top (L). Insert Wood Dowels (A) and Cam (C) into top of the End Panels (N, P) and Center Divider (S). Place Top (L) onto base and fasten by turning Cam (C). Place Cam Stickers (D) onto Cam (C).

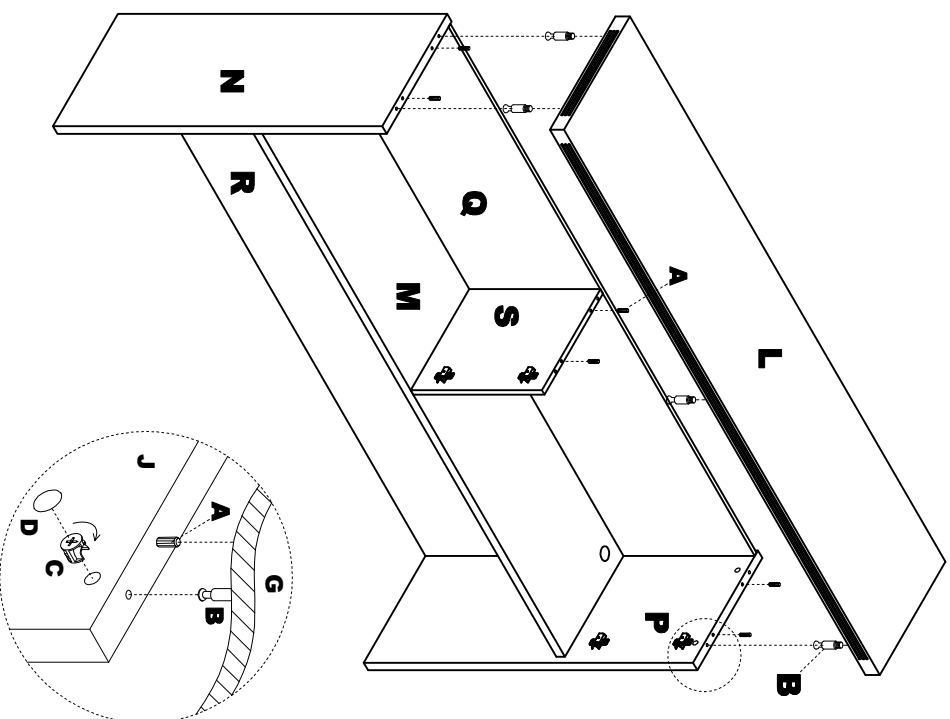

5

5 Position hutch as desired.

6 Attach Plate (G) using Screws (E) to cabinet body and desk top.

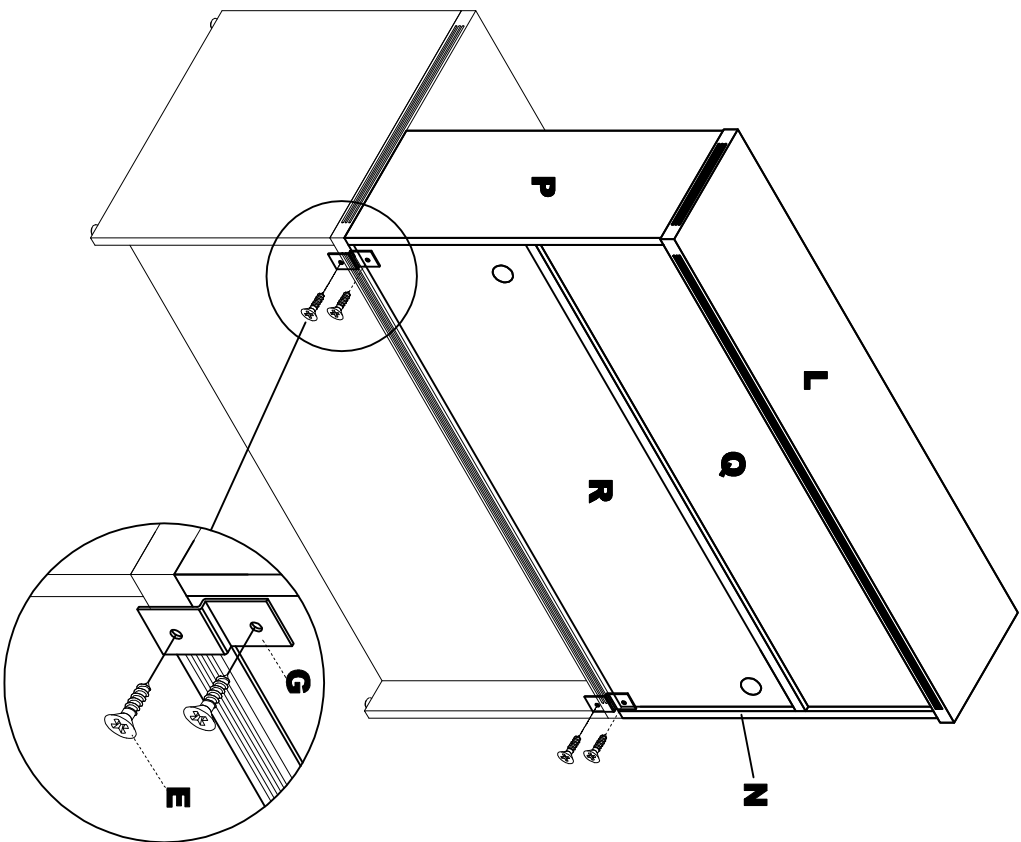

6





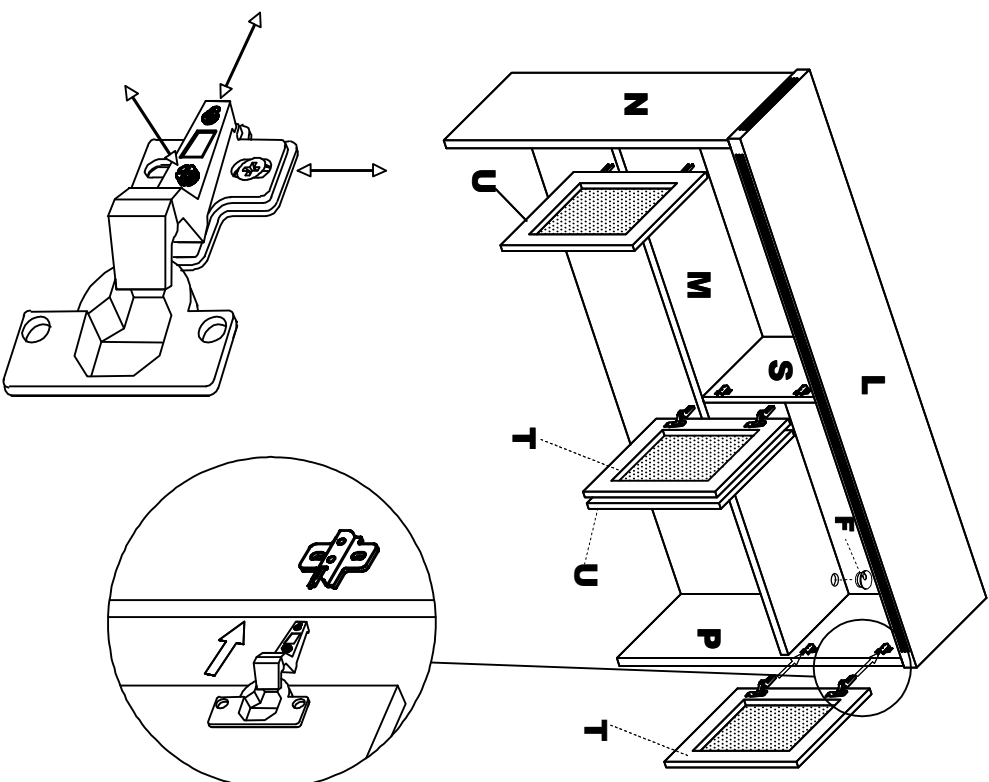

7 Install Doors (U, T) into cabinet. Insert Grommets (F) into Shelf (M) and Back Panel (R).

Adjust door alignment as necessary by using the adjustment screws on the hinges. DO NOT use Power Driver to make these adjustments.



7

Pre-Installed Replacement Parts List

| | | | |
|--|---------------|--|---------------|
| Part | Included Qty. | Part | Included Qty. |
|  REALS051 Hinge | 8 |  REALS013P Hinge Plate - Inner Door | 4 |
|  REALS051P Hinge Plate - Outer Door | 4 |  REALS016 Ø4 x 16mm | 32 |
|  REALS247 Bumper | 4 |  REALS204 Foam Tape | 2 |

8

9