

Aberdeen Series™

Hutch with Wood Doors

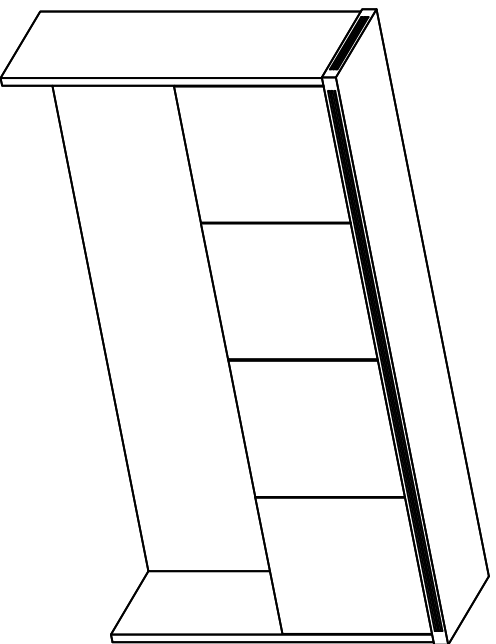







Model No. AHW72, AHW66 & AHW60



ASSEMBLY INSTRUCTIONS

CALL 1-800-822-8037 FOR ASSISTANCE

PARTS LIST

Name	Part	Qty.	Spare Qty.	Name	Part	Qty.	Spare Qty.
A	 REALS004 Wood Dowel HB	20	1	E	 REALS238 Ø4 x 14mm HB	4	1
B	 REALS003 Cam Post HB	20	1	F	 REALS104 Grommet HB	4	
C	 REALS001 Cam Fastener HB	20	1	G	 REALS506 Plate HB	2	
D	 REALS102** Cam Sticker HB	20	1		 AHHB		

Items with HB are in hardware box.

**Denotes Color Code

PARTS LIST

Name	Part	Qty.	Name	Part	Qty.
L*	AH~~L** Top	1	R	AH~~R** Lower Back Panel	1
M	AH~~M** Shelf	1	S	AHS** Center Divider	1
N	AHN** Left Side Panel	1	T*	AHW~~T** Right Side Door	2
P	AHP** Right Side Panel	1	U*	AHW~~U** Left Side Doors	2
Q	AH~~Q** Upper Back Panel	1			

* Available in Cherry (LCR) or Mocha (LDC) finish only.
 ** Denotes Color Code
 ~~ Denotes Size (72, 66, 60)

2

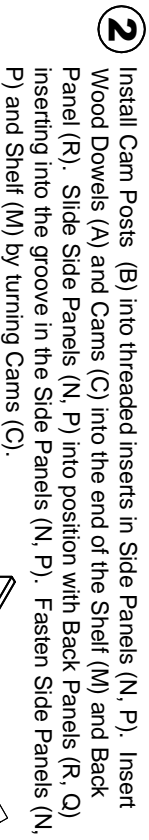
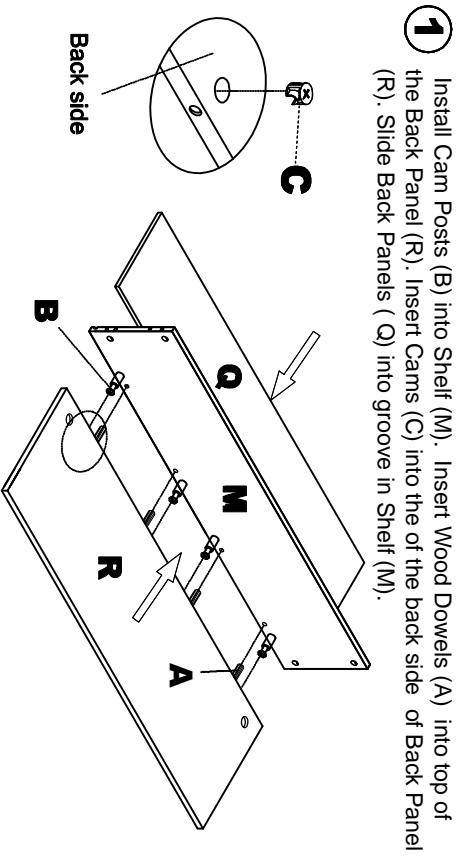

NOTE: The arrow on the face of the Cam (C) should point towards the Cam Post (B) for proper alignment.

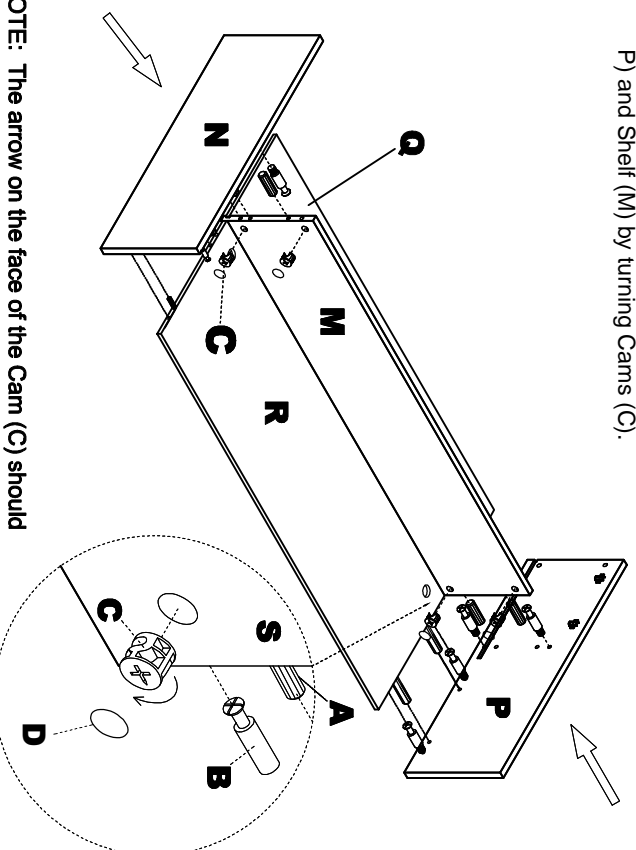

3

3

Stand unit in upright position. Install Cam Posts (B) into Shelf (M). Insert Dowels (A) and Cam (C) into the Center Divider (S). Fasten Center Divider (S) to Shelf (M) by turning Cam (C).

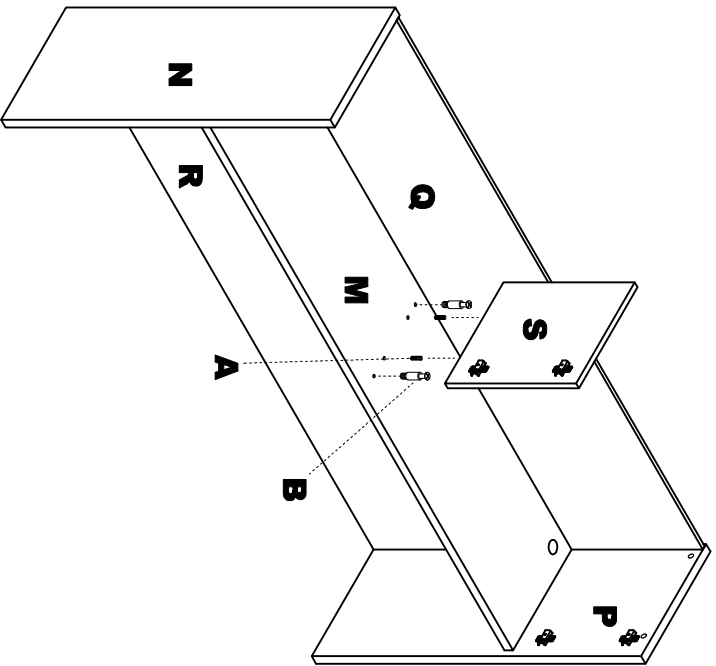

4

4

Install Cam Posts (B) into threaded Inserts in the Top (L). Insert Wood Dowels (A) and Cam (C) into top of the End Panels (N, P) and Center Divider (S). Place Top (L) onto base and fasten by turning Cam (C). Place Cam Stickers (D) onto Cam (C).

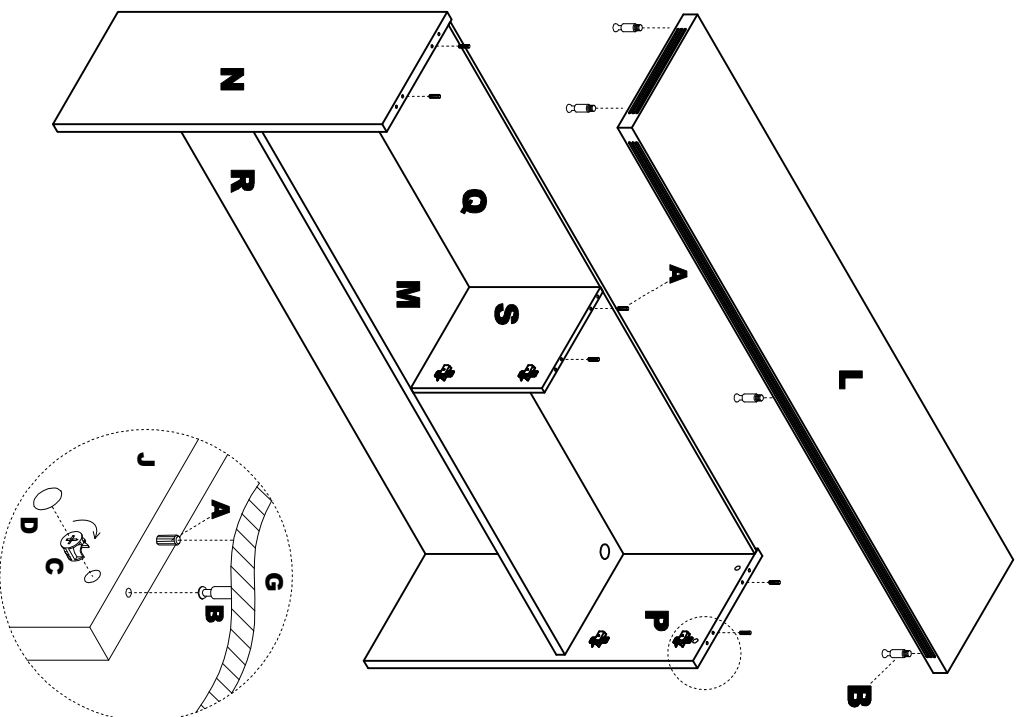

5

5 Position hutch as desired.

6 Attach Plate (G) using Screws (E) to cabinet body and desk top.

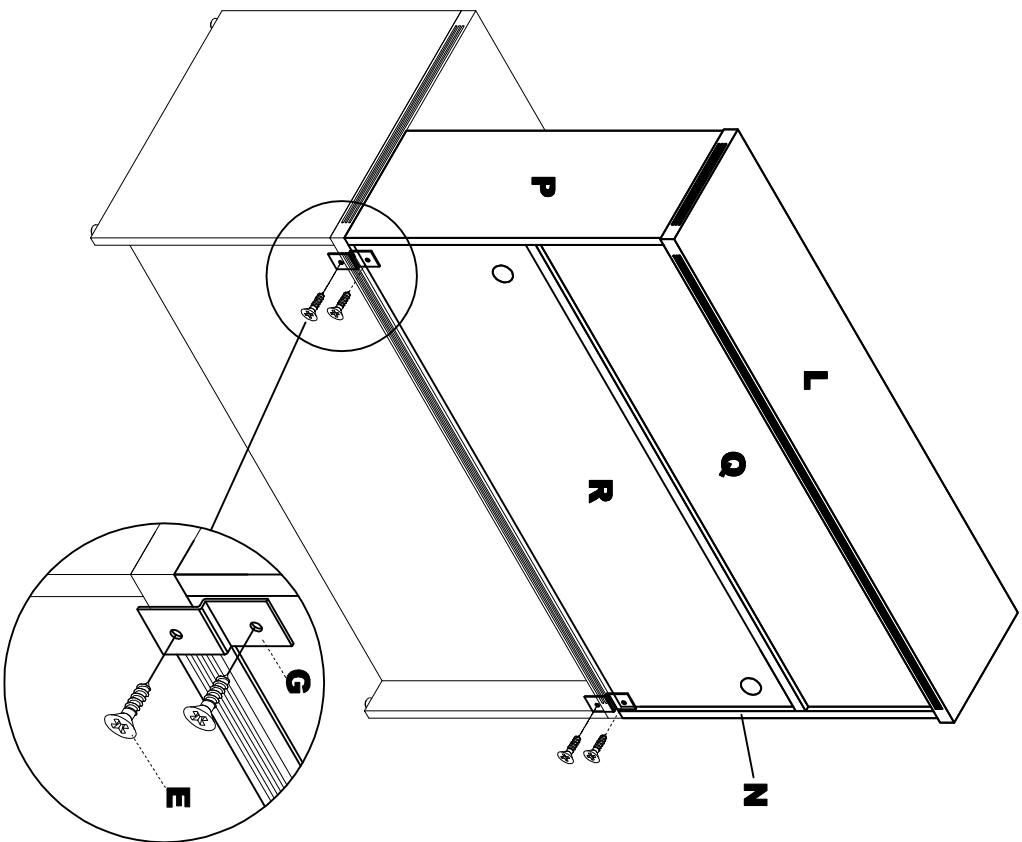

6





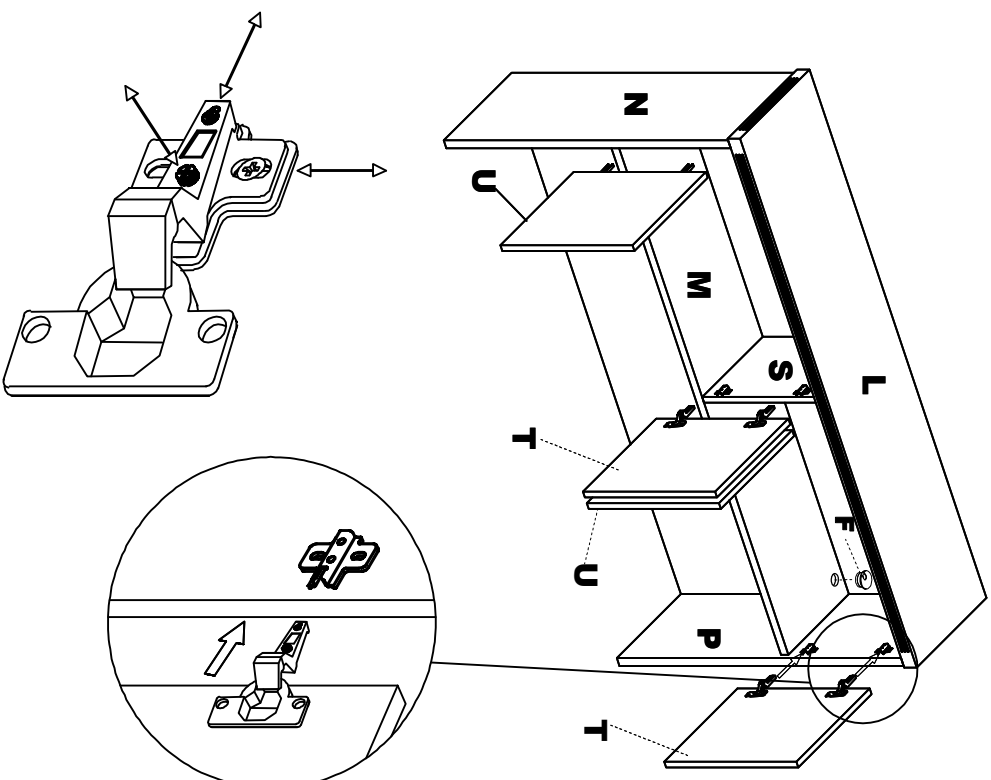

7 Install Doors (U, T) into cabinet. Insert Grommets (F) into Shelf (M) and Back Panel (R).

Adjust door alignment as necessary by using the adjustment screws on the hinges. DO NOT use Power Driver to make these adjustments.



7

Pre-Installed Replacement Parts List

Part	Included Qty.	Part	Included Qty.
 REALS051 Hinge	8	 REALS013P Hinge Plate - Inner Door	4
 REALS051P Hinge Plate - Outer Door	4	 REALS016 Ø4 x 16mm	32
 REALS247 Bumper	4	 REALS204 Foam Tape	2

8

9