

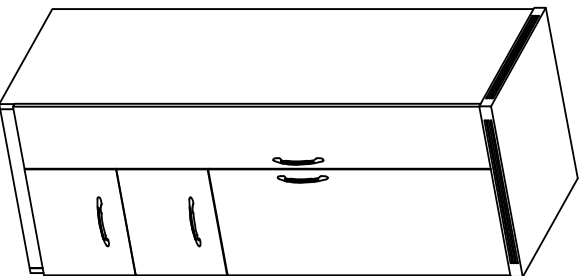





**Aberdeen Series™**  
**Personal Storage Tower**  
**Model No. APST**



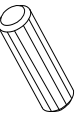





**ASSEMBLY INSTRUCTIONS**



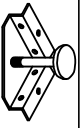



**CALL 1-800-822-8037 FOR ASSISTANCE**







**PARTS LIST**

Name	Part	Qty.	Spare Qty
<b>A</b>	 <b>REALS004</b> Wood Dowel HB	<b>26</b>	<b>3</b>
<b>B</b>	 <b>REALS003</b> Cam Post HB	<b>24</b>	<b>3</b>
<b>C</b>	 <b>REALS001</b> Cam Fastener HB	<b>24</b>	<b>3</b>
<b>D</b>	 <b>REALS102**</b> Cam Sticker HB	<b>24</b>	<b>3</b>
<b>E</b>	 <b>REALS172</b> Garment Bar Support HB	<b>2</b>	
<b>F</b>	 <b>REALS017</b> Ø4mm*16mm HB	<b>4</b>	<b>1</b>

Name	Part	Qty.	Spare Qty
<b>G</b>	 <b>REALS173</b> Garment Bar HB	<b>1</b>	
<b>G1</b>	 <b>REALS230**</b> Cap HB	<b>4</b>	
<b>H1</b>	 <b>REALS008</b> Plate with Leveler HB	<b>4</b>	
<b>H2</b>	 <b>REALS005</b> Ø4mm*16mm HB	<b>24</b>	<b>2</b>
<b>J</b>	 <b>REALS009</b> Shelf Pin HB	<b>24</b>	<b>3</b>
<b>K</b>	 <b>REALS191</b> Handle w/ Screws HB	<b>2</b>	
	 <b>APSTHB</b> Items with HB are in hardware box. **Denotes Color Code		

# PARTS LIST

Name	Part	Qty.
<b>N*</b>	 <b>APSTN***</b> Top	<b>1</b>
<b>P</b>	 <b>APSTP***</b> Left Side Panel	<b>1</b>
<b>Q</b>	 <b>APSTQ***</b> Right Side Panel	<b>1</b>
<b>R</b>	 <b>APSTR***</b> Center Board	<b>1</b>
<b>S</b>	 <b>APSTS***</b> Bottom Panel	<b>1</b>
<b>T</b>	 <b>APSTT***</b> Toe Kick	<b>1</b>
<b>U</b>	 <b>APSTU***</b> Fixed Shelf	<b>1</b>

Name	Part	Qty.
<b>V</b>	 <b>APSTV***</b> Large Shelf	<b>2</b>
<b>W</b>	 <b>APSTW***</b> Small Shelf	<b>4</b>
<b>X</b>	 <b>APSTX***</b> Back Panel	<b>1</b>
<b>Y*</b>	 <b>APSTY***</b> Left Door	<b>1</b>
<b>Z*</b>	 <b>APSTZ***</b> Right Door	<b>1</b>
<b>A1</b>	 <b>APST2***</b> Drawers - Set of 2	<b>2</b>

\* Available in Cherry (LCR) or Mocha (LDC) finish only.

\*\* Denotes Color Code

**2**

**1** Insert Dowels (A) into Toe Kick (T). Insert Dowels (A) from Toe Kick (T) into Bottom Panel (S). Install Garment Bar Support (E) to Left Side Panel (P) and Center Panel (R) using Screws (F).

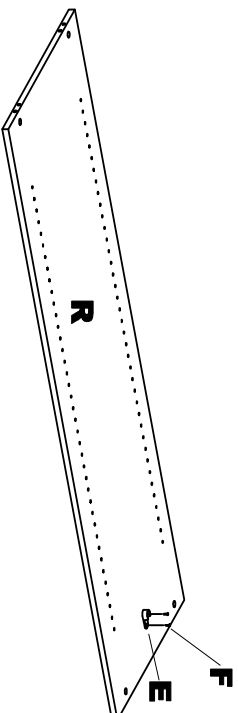
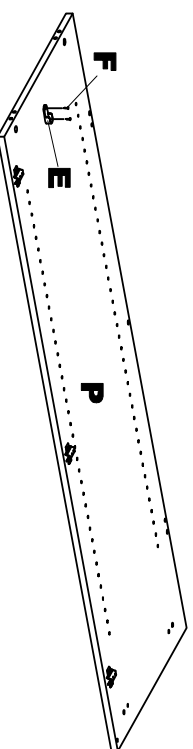
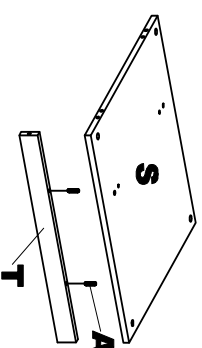

**3**

**2**

Install Cam Posts (B) into threaded Inserts in the Bottom Panel (S). Insert Dowels (A) and Camms (C) into Center Panel (R), Position Center Panel with Grommet Bar Support (E) 'UP'. Attach the Center Panel (R) to the Bottom Panel (S) by turning Camms (C).

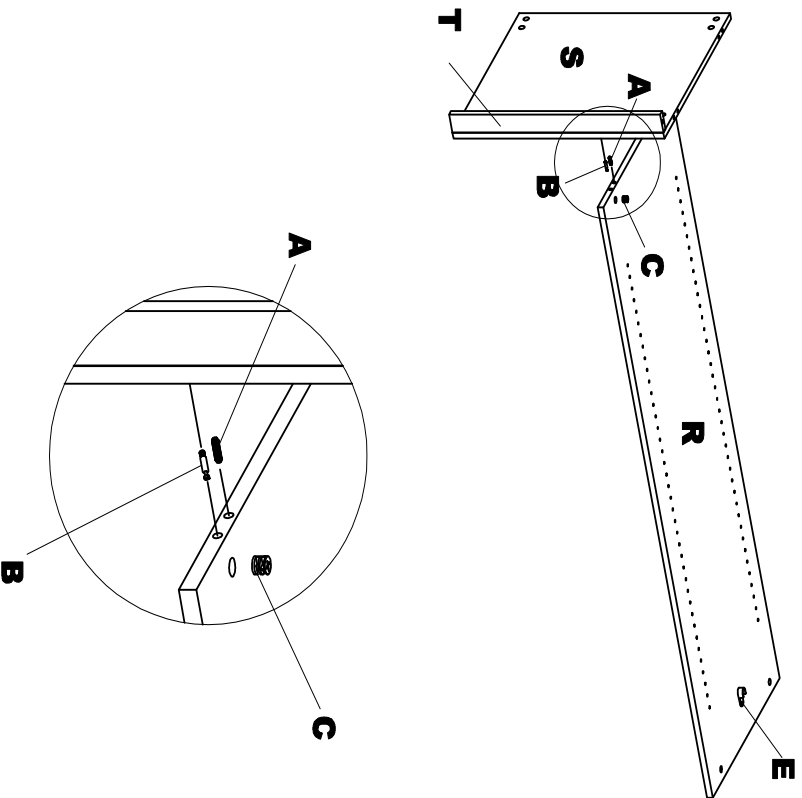

**NOTE:** The arrow on the face of the Cam (C) should point towards the Cam Post (B) for proper alignment.

**4**

**3**

Insert Dowels (A) and Camms (C) into Bottom Panel (S) and Fixed Shelf (U). Install Cam Posts (B) into threaded Inserts in Right Side Panel (Q) and Center Panel (R). Attach Fixed Shelf (U) and Right Side Panel (Q) to Bottom Panel (S) and Center Panel (R) by turning Camms (C).

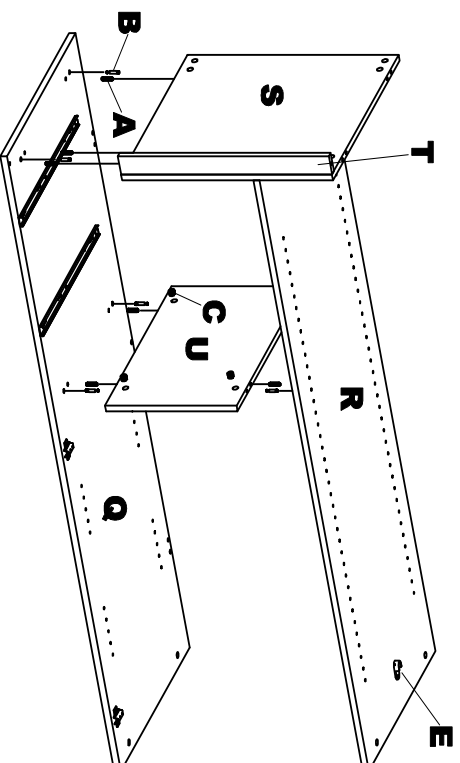

**5**

**4**

Install Cam Posts (B) into threaded Inserts in Right and Left Side Panels (P, Q). Insert Dowels (A) and Cam (C) into Back Panel (X) and Bottom Panel (S). Attach Back Panel (X) and Left Side Panel (P) to Right Side Panel (Q) and Bottom Panel (S) by turning Cam (C).

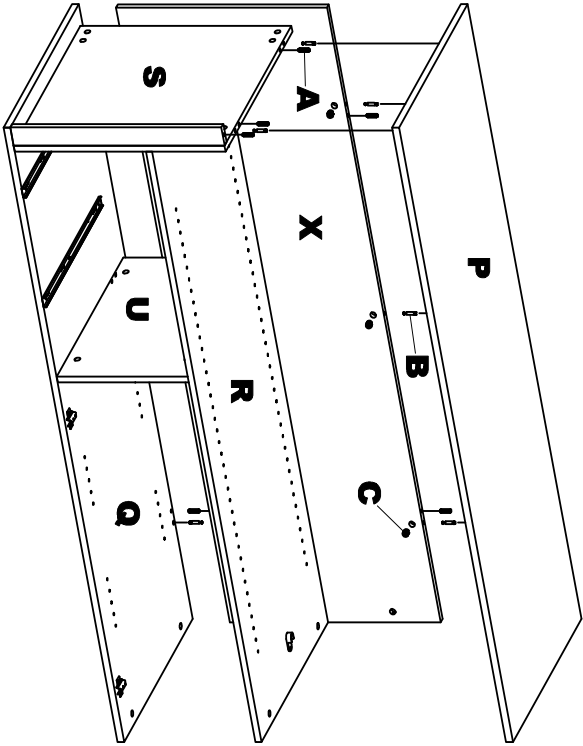

**6**

**5**

Install Plate with Leveler (H1) to the bottom of cabinet using Screws (H2). Insert Garment Bar (G) into Garment Bar Supports (E). Insert Dowels (A) and Cam (C) into Left and Right Side Panels (P, Q) and Back Panel (X). Install Cam Posts (C) into threaded inserts in the underside of the Top (N). Attach Top (N) to the Left and Right Side Panels (P, Q) and Back Panel (X) by turning Cam (C).

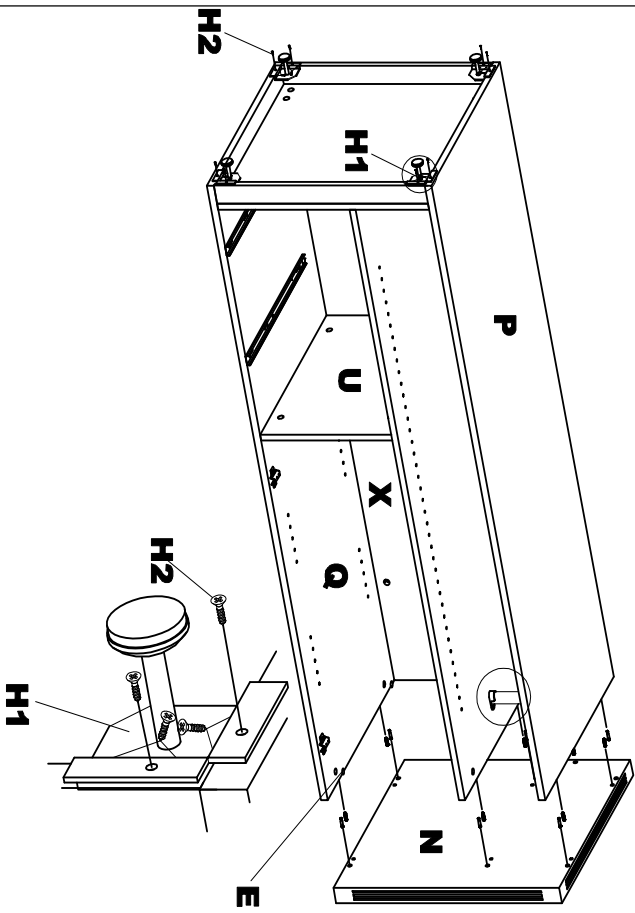
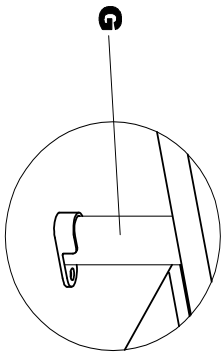

**7**

- 6** Insert Shelf Pins (J) into Left and Right Side Panels (P, Q) and Center Panel (R) in the desired position. Install Shelves (V, W) onto Shelf Pins (J).  
 Apply Cam Stickers (D) over exposed Camms (C). Insert Caps (G1) into adjustment holes for levelers.

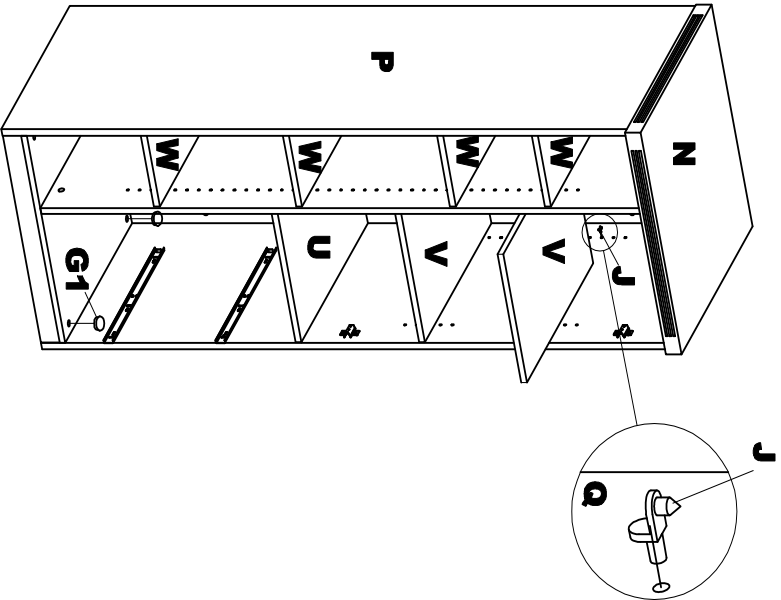

- 7** Attach Handles (K) to Doors (Y,Z) using screws supplied with Handle.  
 Install Doors (Y,Z) onto cabinet.  
 Adjust doors for alignment as necessary by using the adjustment screws on the hinges. **DO NOT** use Power Driver to make these adjustments.

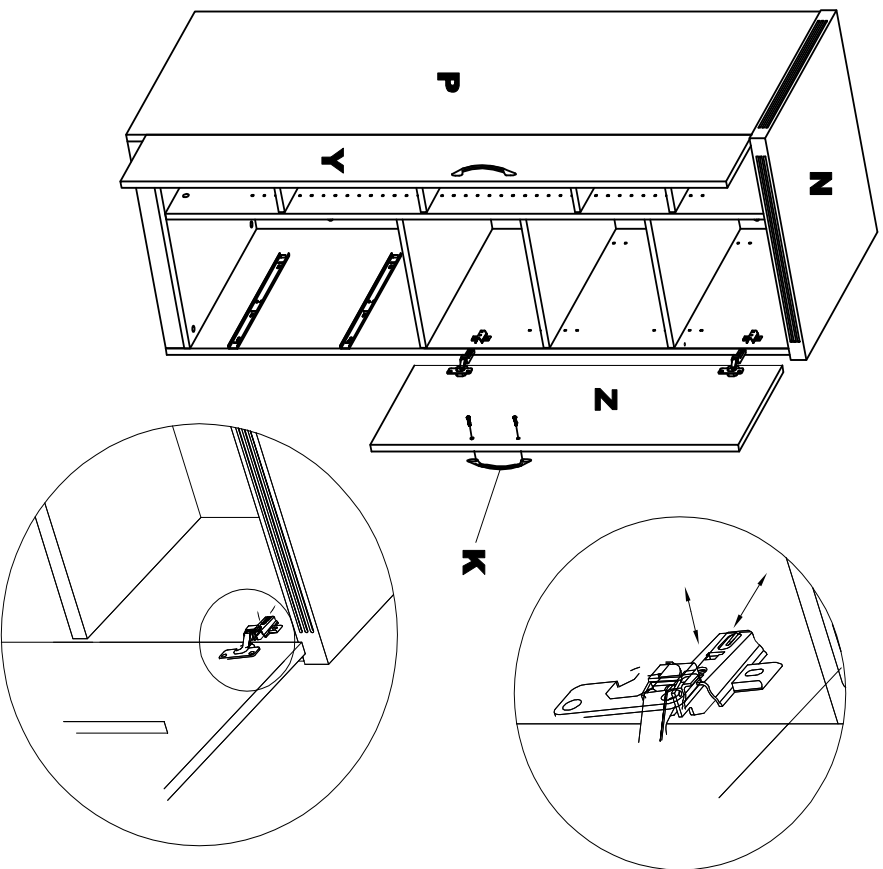





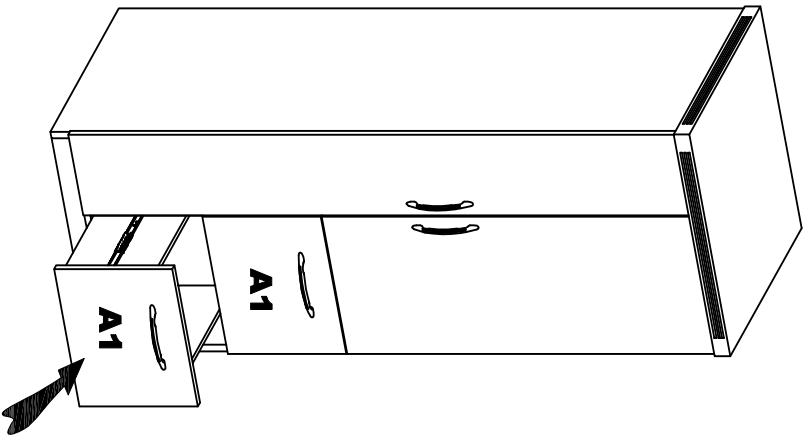

8

Install Drawers (A1) into cabinet by extending the slides in the cabinet and then aligning the grooves in the slide on the drawer with the grooves in the extended slides.



10

# Pre-Installed Replacement Parts List

Part	Included Qty.	Part	Included Qty.
 <b>REALS013</b> Hinge - Straight	5	 <b>REALS013P</b> Hinge Plate - Short	5
 <b>REALS018</b> Ø4 x 14mm	20	 <b>REALS059</b> 18" Drawer Slide - Pair	2
 <b>REALS191</b> Handle w/ Screws	2	 <b>REALS247</b> Bumper	4
 <b>REALS121</b> Ø3 x 14mm	32		

11