

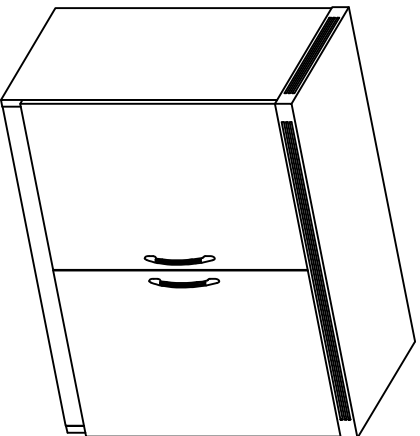





**Aberdeen Series™
Storage Cabinet
Model No. ASC**



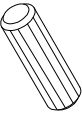





ASSEMBLY INSTRUCTIONS

CALL 1-800-822-8037 FOR ASSISTANCE

PARTS LIST





Name	Part	Qty.	Spare Qty
A	 REALS004 Wood Dowel HB	21	2
B	 REALS003 Cam Post HB	18	2
C	 REALS001 Cam Fastener HB	18	2
D	 REALS102** Cam Sticker HB	18	2
E	 REALS009 Shelf Support Pin HB	4	
F	 REALS191 Handle w/ Screws HB	2	



Name	Part	Qty.	Spare Qty
G	 REALS008 Corner Bracket w/ Glide HB	4	
H	 REALS203 Ø4 x 16mm HB	24	2
H1	 REALS230** Cap HB	4	
J	 REALS025 Door Stop HB	1	
K	 REALS017 Ø3.5 x 16mm HB	2	
	 ASC HB		

Items with HB are in hardware box.

**Denotes Color Code

PARTS LIST

Name	Part	Qty.
M*	 ASCM*** Top	1
N	 ASCN*** Left Side Panel	1
P	 ASCP*** Right Side Panel	1
Q	 ASCQ*** Bottom Panel	1
R	 ASCR*** Toe Kick	1

Name	Part	Qty.
S	 ASCS*** Back Panel	1
T	 ASCT*** Movable Shelf	1
U*	 ASCU*** Wood Door	2

* Available in Cherry (LCR) or Mocha (LDC) finish only.

**Denotes Color Code

- 1 Insert Wood Dowels (A) into Toe Kick (R). Press Toe Kick (R) to Bottom Panel (Q).

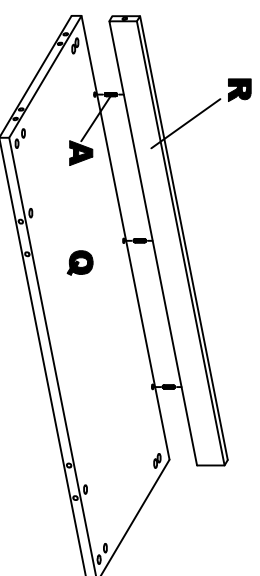

- 2 Attach Door Stop (J) to Top (M) using Screws (K).

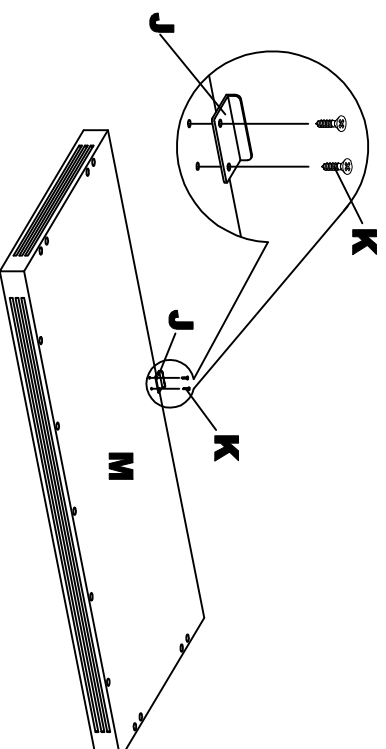

3

Insert Wood Dowels (A) into sides of Bottom (Q). Insert Camms (C) into Bottom (Q). Install Cam Posts (B) into threaded Inserts in Back Panel (S). Attach Bottom (Q) to Back Panel (S) by turning Camms (C).

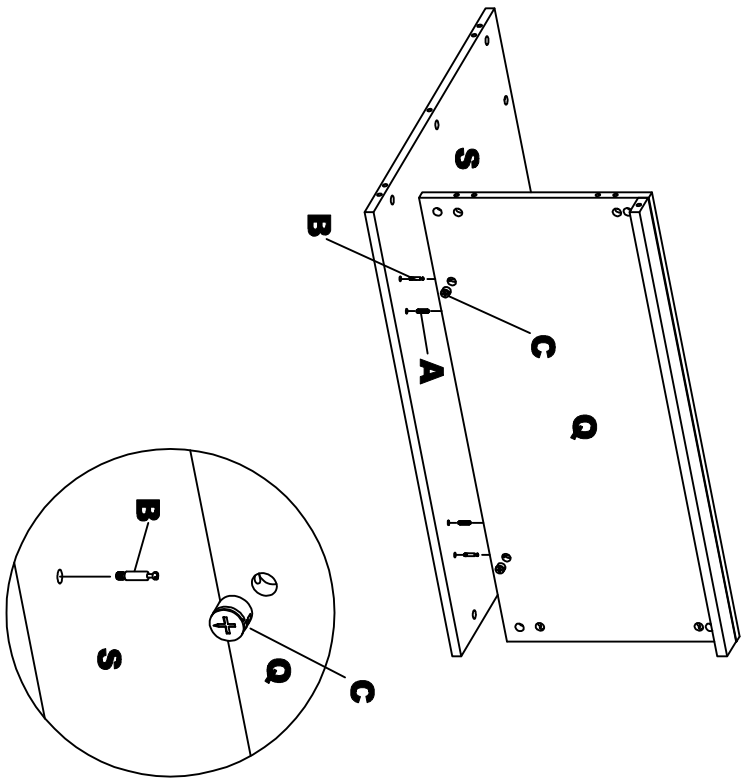

NOTE: The arrow on the face of the Cam (C) should point towards the Cam Post (B) for proper alignment.

4

4

Insert Wood Dowels (A) into Bottom (Q), Toe Kick (R), and Back Panel (S). Insert Camms (C) into Bottom (Q) and Back Panel (S). Install Cam Posts (B) into threaded inserts in Left and Right Side Panels (N & P). Attach Left and Right Side Panels (N & P) to Bottom (Q) and Back Panel (S) by turning Camms (C).

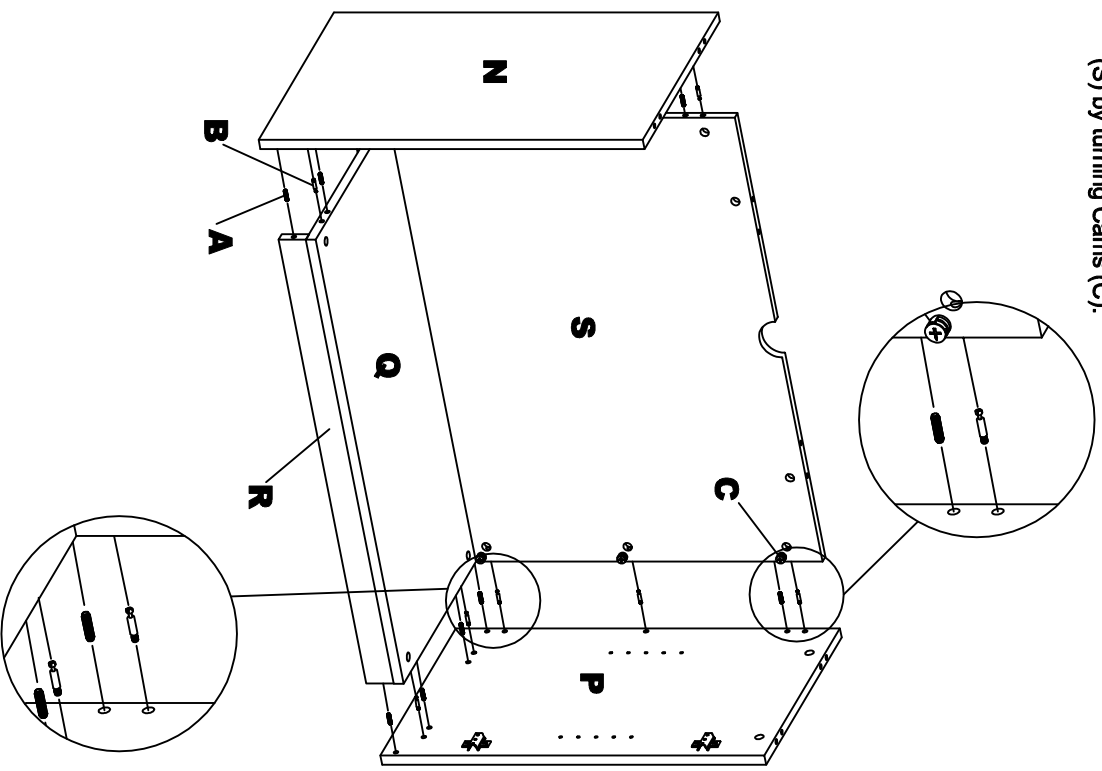

5

7

Install Shelf Support Pins (E) into Left and Right Side Panel (N & P).
Install Moveable Shelves (T).

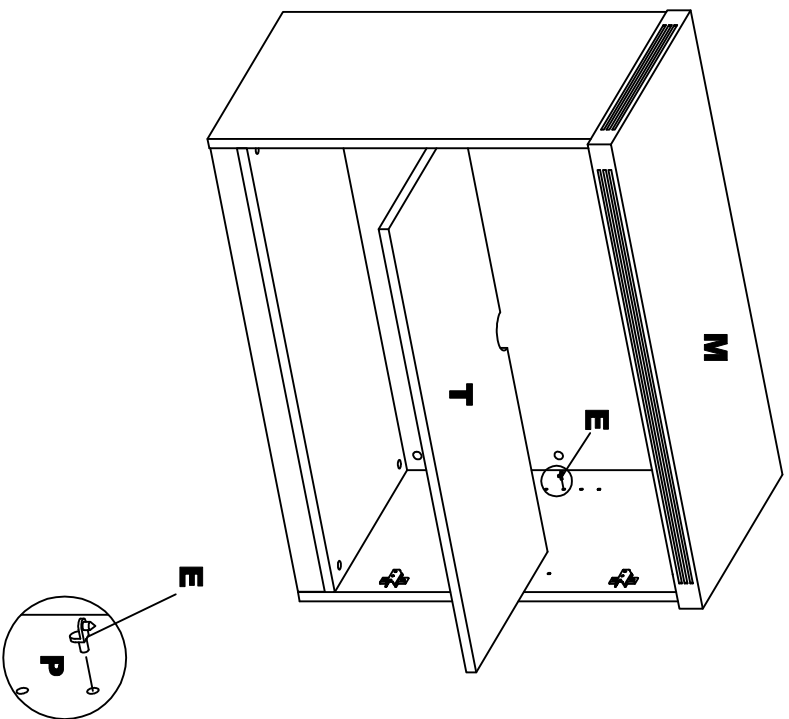

8



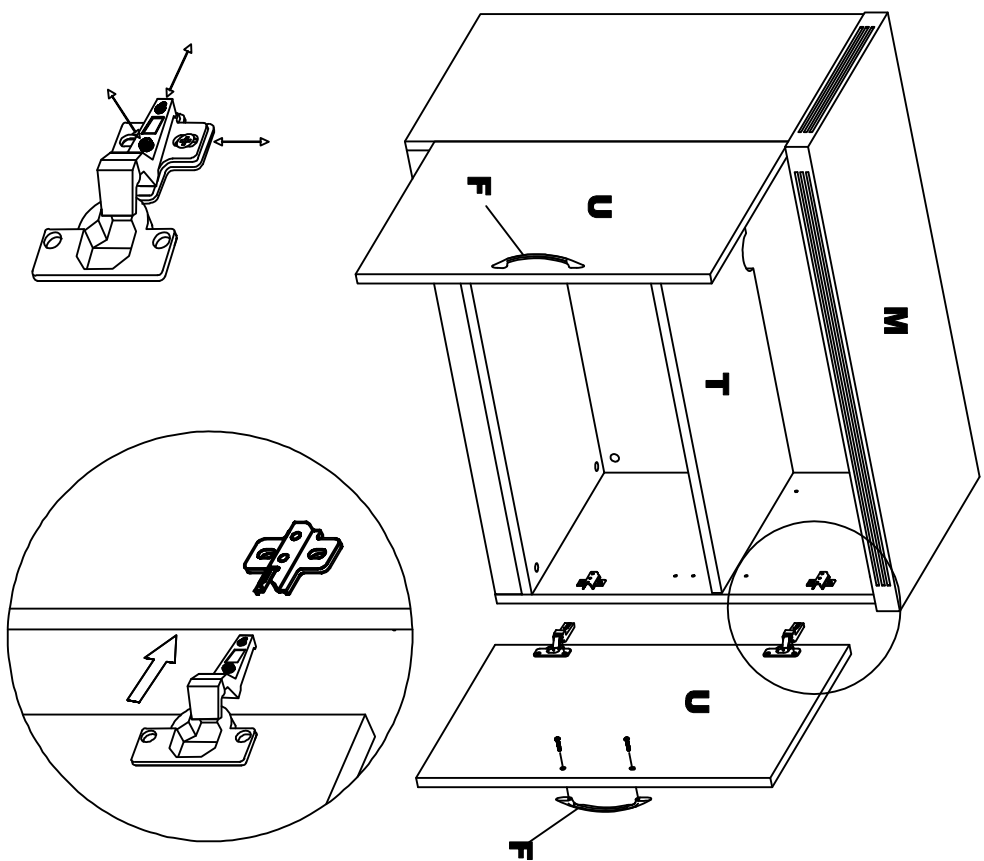

8

Attach Handles (F) to Wood Doors (U) using screws supplied with Handle. Install Wood Doors (U) onto cabinet.
Adjust doors for alignment as necessary by using the adjustment screws on the hinges. **DO NOT** use Power Driver to make these adjustments.



9

Pre-Installed Replacement Parts List

Part	Included Qty.	Part	Included Qty.
 REALS013 Hinge - Straight	4	 REALS013P Hinge Plate - Short	4
 REALS247 Bumper	2	 REALS018 Ø4 x 14mm	16