

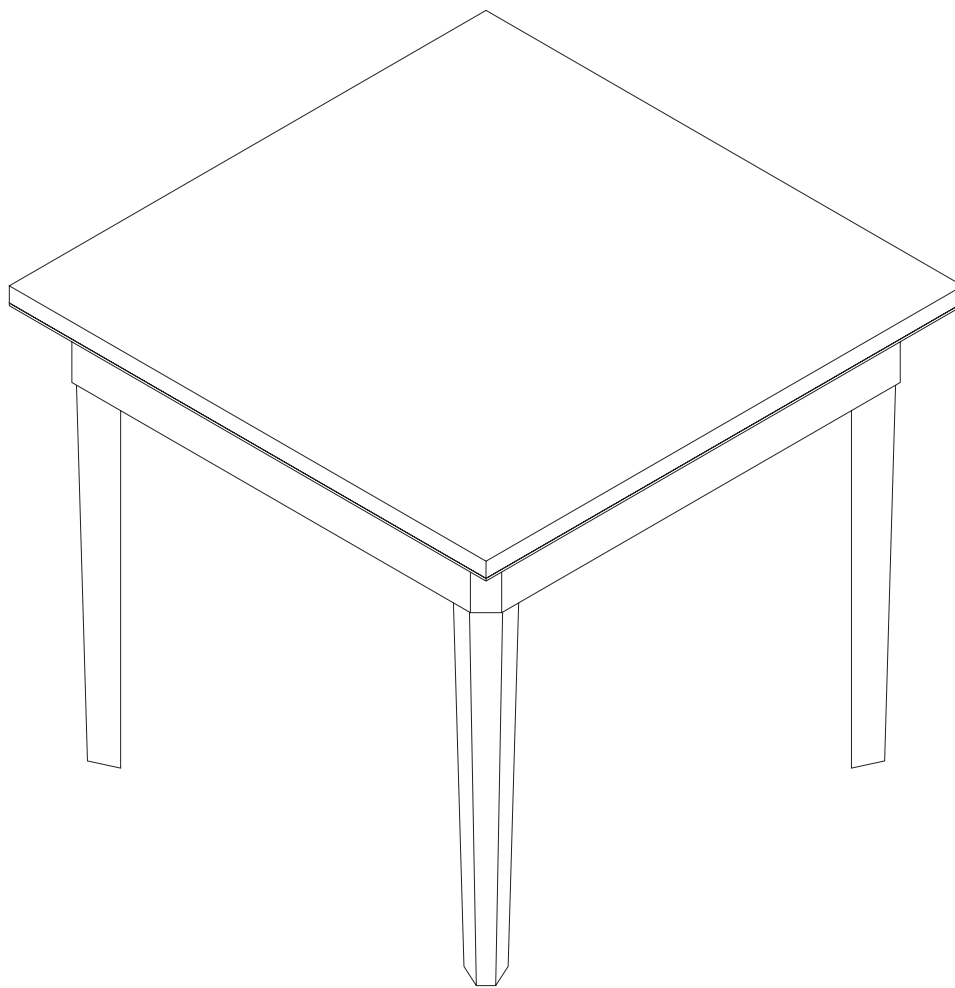



Tiffany Industries™
A MAYLINE GROUP COMPANY





End- Square Table Model No. CTS

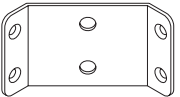

ASSEMBLY INSTRUCTIONS
CALL 1-800-822-8037 FOR ASSISTANCE

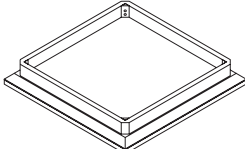
PARTS LIST

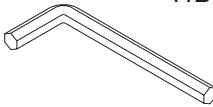
Name	Part	Qty.	Spare Qty
A*	 HB REALS005 4mm x 16mm	16	2
B*	 HB REALS082 6mm x 35mm	8	
C	 HB REALS083 Corner Bracket	4	

Name	Part	Qty.
D*	 CTS**	1
E*	 CTSE** Leg	4
F	 HB REALS084 Allen Wrench	1
	 CTSHB	

Items with HB are in the hardware box.
 *For Individual Items, Order By Part Number.
 ** Denotes Color Code

1

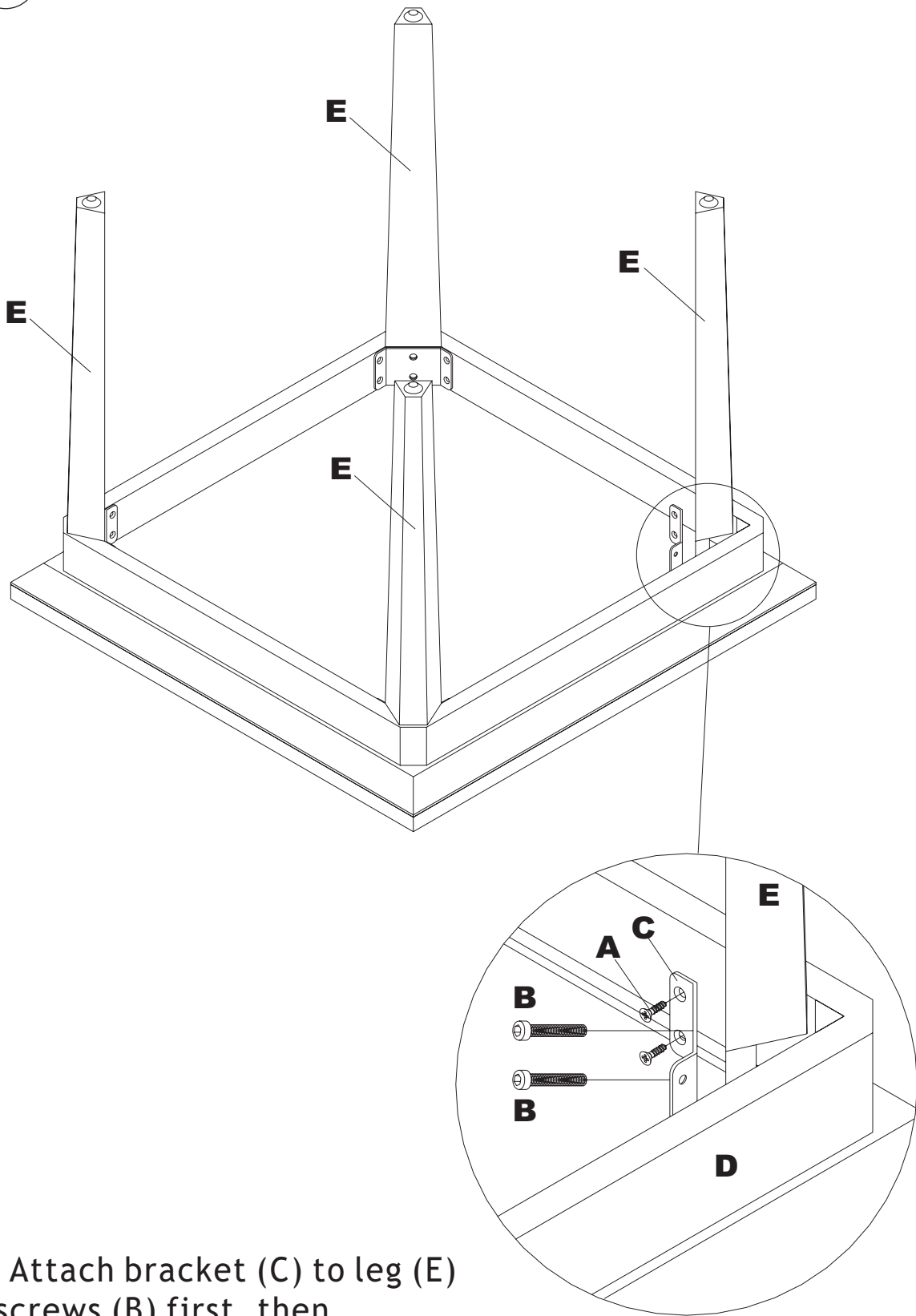

Note: Attach bracket (C) to leg (E) using screws (B) first, then use screws (A) to attach bracket to apron under top (D).

