

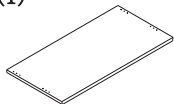

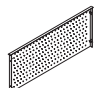

<p>(1)</p>  <p>1PCS</p>	<p>(2)</p>  <p>1PCS</p>	<p>(3)</p>  <p>Assembly template 1PCS</p>	<p>(E)</p> <p>4*16mm</p>  <p>4PCS</p>	<p>(F)</p> <p>4*20mm</p>  <p>36PCS+2</p>	<p>(M)</p>  <p>4PCS</p>
--	--	--	--	---	--

STEP 1

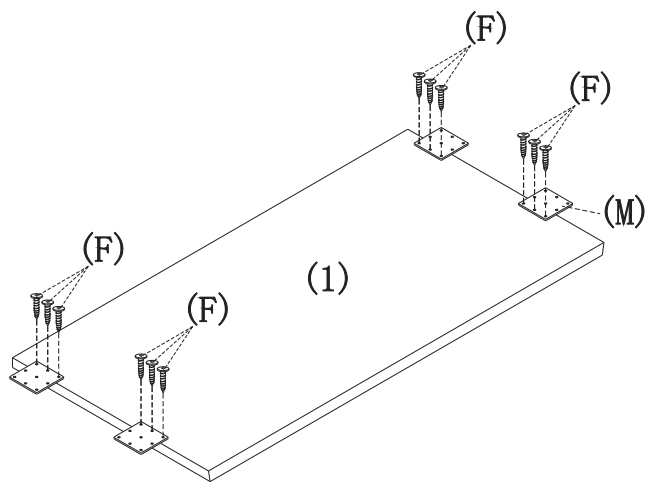

STEP 2

Notes:
Please put the metal modesty panel "(2)" on the pedestal carefully. Then use the Assembly template "(3)" to line-up the backboard of the pedestal and fasten the "(2)" by four screws "(E)".

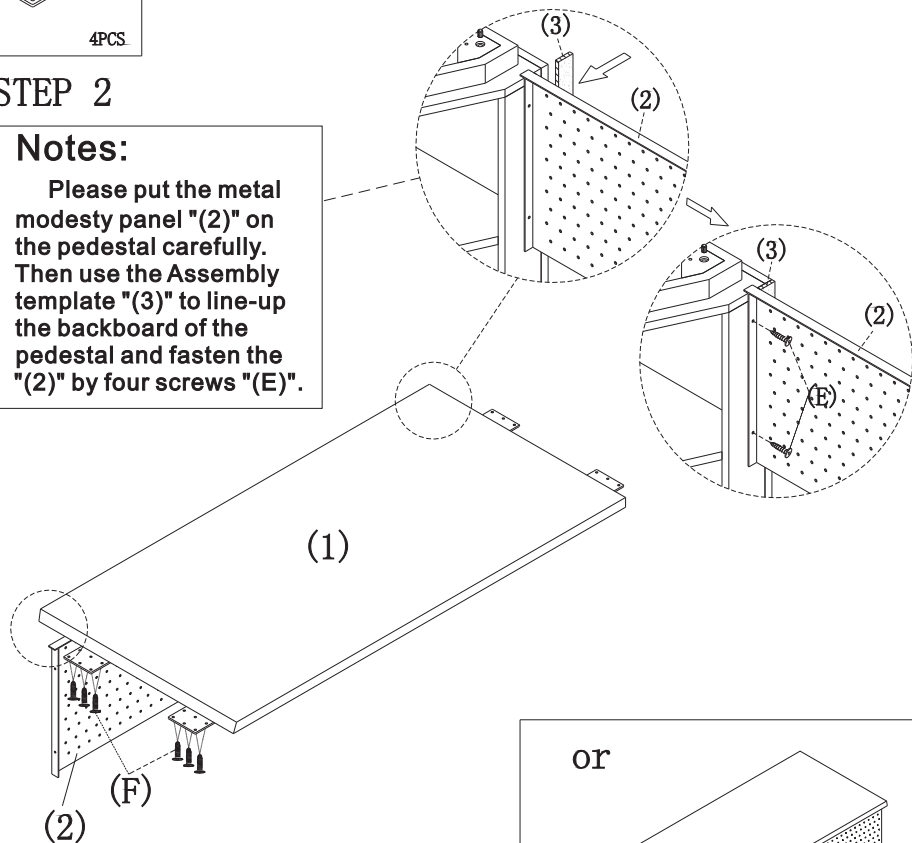

or

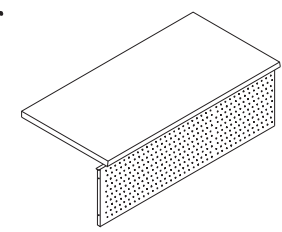

NAME : BRIDGE
TYPE : E -BR2448
SPECIFICATION : 48 "W *24 "D *29 "H

