

# ASSEMBLY INSTRUCTIONS

## Mercado Optima Mid-Back Chair

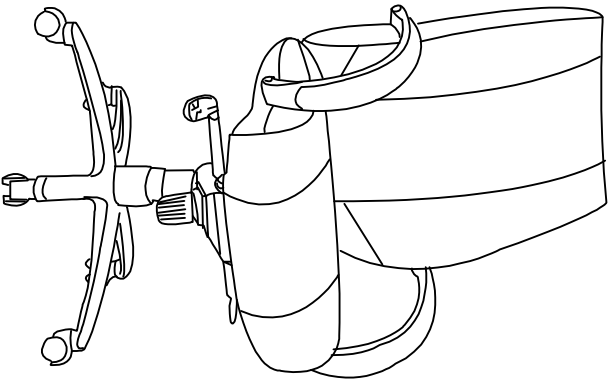











### Model No. OPM

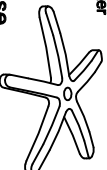

## PARTS LIST OPM

When ordering components, specific color and/or size information may be required.  
Contact a Mayline Customer Service Representative. 1-800-822-8037

\* Individual Items, Order by part number.  
\*\* Denotes Color Code.

|  |   |          |          |
|--|---|----------|----------|
| <b>A*</b><br>Reference Letter                    |  | Quantity | <b>1</b> |
| Part Number<br><b>101449**</b> Back              |   |          |          |
| <b>B*</b><br>Reference Letter                    |    | Quantity | <b>1</b> |
| Part Number<br><b>101488**</b> Seat              |   |          |          |
| <b>C*</b><br>Reference Letter                    |    | Quantity | <b>2</b> |
| Part Number<br><b>101451</b> Arms (pair)         |   |          |          |
| <b>D*</b><br>Reference Letter                    |    | Quantity | <b>1</b> |
| Part Number<br><b>101425</b> Height Lever        |   |          |          |
| <b>E*</b><br>Reference Letter                    |    | Quantity | <b>5</b> |
| Part Number<br><b>101400</b> Castor (5 per pack) |   |          |          |
| <b>F*</b><br>Reference Letter                    |    | Quantity | <b>1</b> |
| Part Number<br><b>101412</b> Base                |   |          |          |
| <b>G*</b><br>Reference Letter                    |  | Quantity | <b>1</b> |
| Part Number<br><b>101401</b> Cylinder            |   |          |          |
| <b>H*</b><br>Reference Letter                    |   | Quantity | <b>1</b> |
| Part Number<br><b>101406</b> Cylinder Cover      |   |          |          |
| <b>101415*</b> Hardware Bag                      |   |          |          |
| <b>J</b><br>Reference Letter                     |    | Quantity | <b>8</b> |
| Screw 1/4-20 x 1"                                |   |          |          |
| <b>K</b><br>Reference Letter                     |    | Quantity | <b>4</b> |
| Screw 5/16-18 x 2"                               |   |          |          |
| <b>L*</b><br>Reference Letter                    |    | Quantity | <b>4</b> |
| 101452 Amn Plug                                  |   |          |          |
| <b>M</b><br>Reference Letter                     |    | Quantity | <b>1</b> |
| Allen Wrench                                     |   |          |          |
| <b>N</b><br>Reference Letter                     |    | Quantity | <b>1</b> |
| Allen Wrench                                     |   |          |          |
|  |   |          | <b>1</b> |

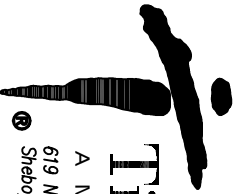

**Tiffany Industries™**

A MAYLINE GROUP COMPANY

619 N. Commerce, P.O. Box 728  
Sheboygan, WI 53082-0728

Toll Free: 1-800-822-8037  
FAX: 920-457-7388  
On Line: www.mayline.com

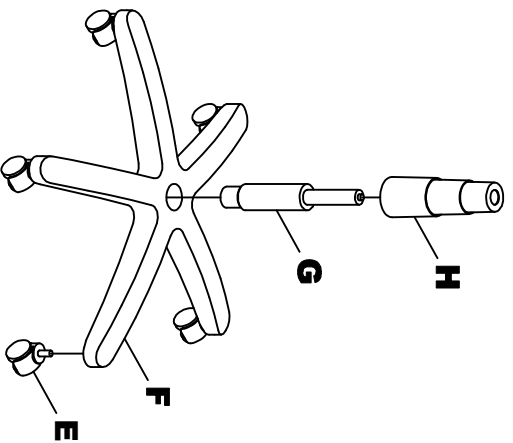

1. Place Base (F) upside down and push Casters (E) firmly into base. 5 places.
2. Turn Base right side up and insert Cylinder (G) into center hole of Base.
3. Place Cylinder Cover (H) over Cylinder.

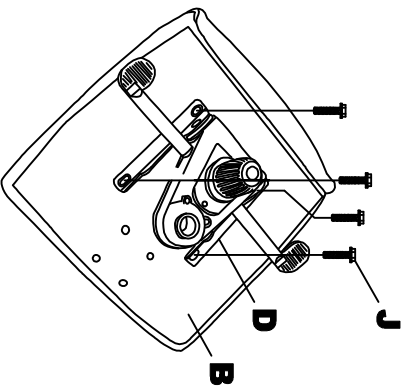

4. Assemble Mechanism (D) onto Seat (B) using Screws (J) 4 places.

**2**

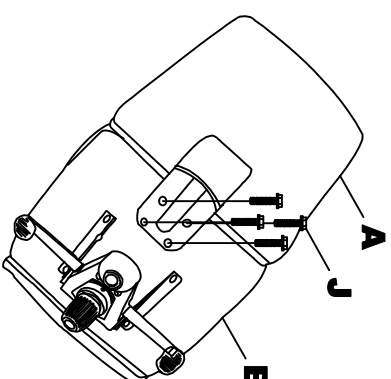

5. Assemble Back (A) onto Seat (B) using Screws (J) 4 places. **DO NOT TIGHTEN SCREWS** at this time. This will allow a tolerance when assembling arms.

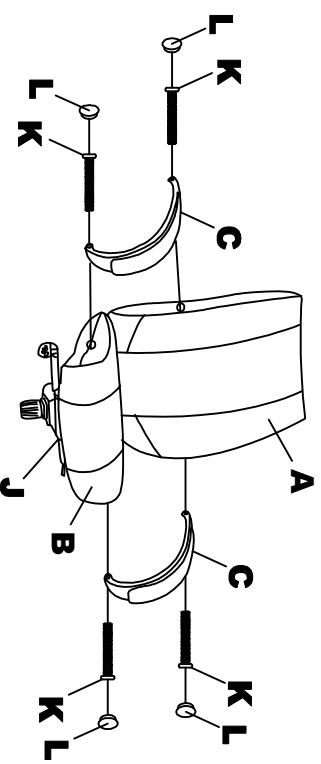

6. Assemble Arm (C) 2 places onto Back (A) & Seat (B) using Screws (K) 4 places. **DO NOT TIGHTEN SCREWS** at this time.
7. After both arms are installed tighten all Screws (K) 4 places, Screws (J) 4 places.
8. Insert Arm Plug (L) into Arm (C) 4 places.

**3**

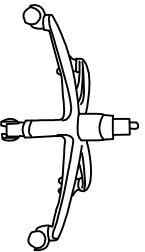
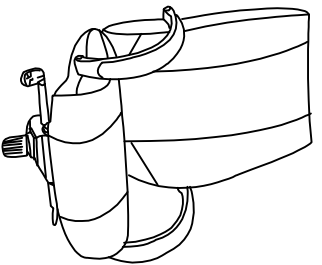

8. Carefully place chair assembly onto base assembly.

**NOTE:**

Periodically (Every 90 days) make sure screws are fully tightened.

**OPERATING INSTRUCTIONS FOR DELUXE KNEE-TILT MECHANISM**

**1. Seat Height Adjustment.**

To raise the seat, pull lever upward and raise your body up slightly to allow the chair to rise to the desired height.

To lower the seat, pull lever upward and apply weight downward on the seat.

**2. Seat Tilt Adjustment Lock**

Pull lever upward and allow the chair to tilt backwards.

To lock to the desired position push lever downward.

To release tilt adjustment, pull lever upward, apply weight onto the back cushion and then lean forward.

**3. Tilt Tension Control Knob.**

Turn knob clockwise to increase tilt tension.

Turn knob counter-clockwise to decrease tilt tension.

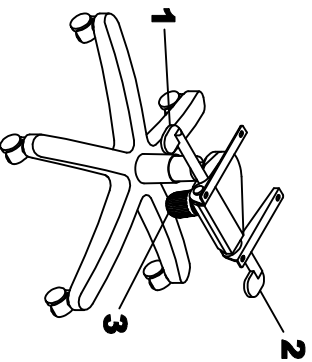

**4**