

ASSEMBLY INSTRUCTIONS

Mercado Silhouette High-Back Chair

Model No. SS

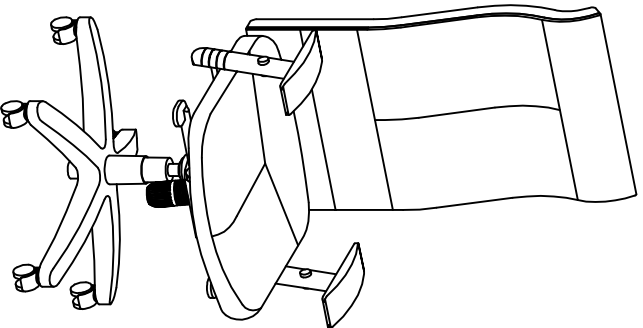











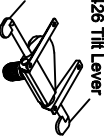

PARTS LIST SS

When ordering components, specific color and/or size information may be required. Contact a Mayline Customer Service Representative. 1-800-822-8037

** Individual Items, Order by part number.*

*** Denotes Color Code.*

Reference Letter A*		Quantity 1	Reference Letter G*		Quantity 1
Part Number 101437** Back			Part Number 101401 Cylinder		
Reference Letter B*		Quantity 1	Reference Letter H*		Quantity 1
Part Number 101446** Seat			Part Number 101406 Cylinder Cover		
Reference Letter C*		Quantity 2	Part Number 101413* Hardware Bag		Quantity 1
Part Number SSMARM Arms (pair)			Reference Letter J		Spare 1
Reference Letter D*		Quantity 1	Reference Letter K		Quantity 6
101425 Height Lever			Reference Letter L		Quantity 4
Part Number 101402 Mechanism			Reference Letter M		Quantity 1
Reference Letter E*		Quantity 5	Reference Letter N		Quantity 1
Part Number 101400 Caster (5 per pack)					
Reference Letter F*		Quantity 1			
Part Number 101411 Base					

1

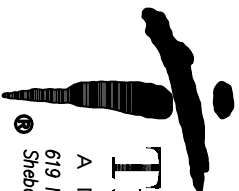

Tiffany Industries™

A MAYLINE GROUP COMPANY

619 N. Commerce, P.O. Box 728
Sheboygan, WI 53082-0728

Toll Free: 1-800-822-8037

FAX: 920-457-7388

On Line: www.mayline.com

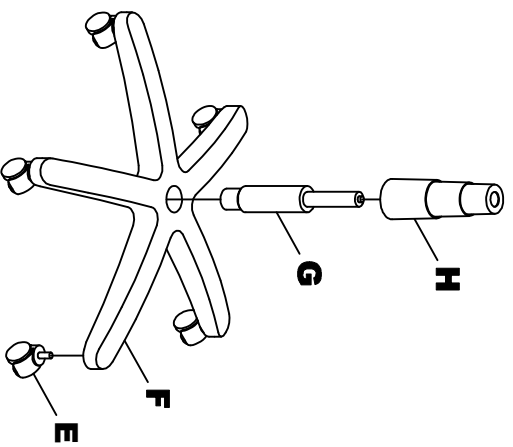

1. Place Base (F) upside down and push Casters (E) firmly into base. 5 places.
2. Turn Base right side up and insert Cylinder (G) into center hole of Base.
3. Place Cylinder Cover (H) over Cylinder.

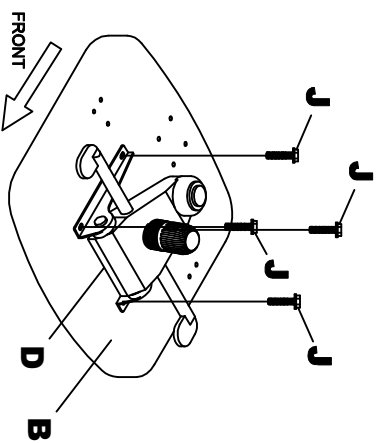

4. Assemble Mechanism (D) onto Seat (B) using Screws (J) 4 Places.

2

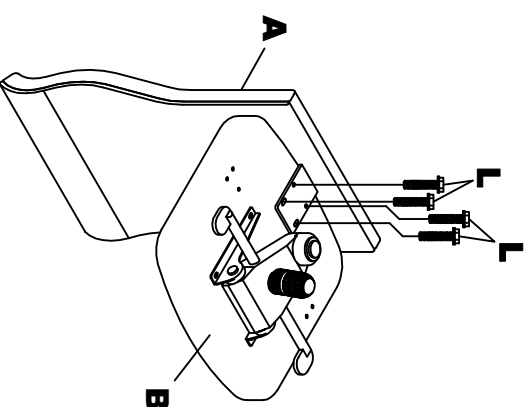

5. Assemble Back (A) onto Seat (B) using Screws (L) 4 places.

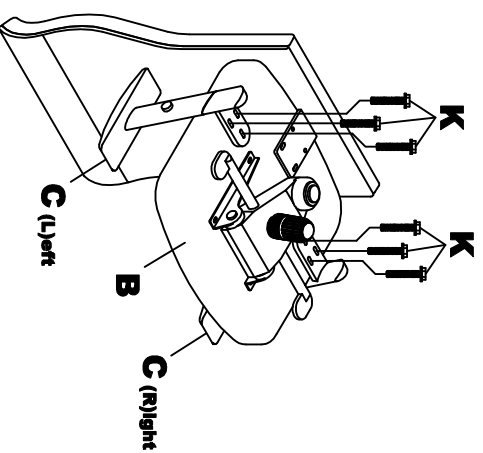

6. Assemble Arm (C) 2 places onto Seat (B) using Screws (K) 6 places.

3

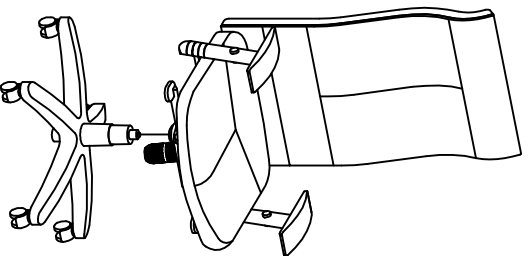

7. Carefully place chair assembly onto base assembly.

Note:

Periodically (Every 90 days) make sure screws are fully tightened.

OPERATING INSTRUCTIONS FOR DELUXE KNEE-TILT MECHANISM

1. Seat Height Adjustment.

To raise the seat, pull lever upward and raise your body up slightly to allow the chair to rise to the desired height.

To lower the seat, pull lever upward and apply weight downward on the seat.

2. Seat Tilt Adjustment Lock

Pull lever upward and allow the chair to tilt backwards.

To lock to the desired position push lever downward.

To release tilt adjustment, pull lever upward, apply weight onto the back cushion and then lean forward.

3. Tilt Tension Control Knob.

Turn knob clockwise to increase tilt tension.

Turn knob counter-clockwise to decrease tilt tension.

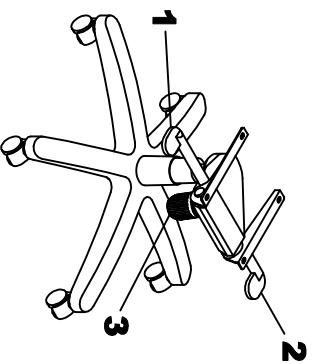

4