

ASSEMBLY INSTRUCTIONS
MERCADO SILHOUETTE MID-BACK CHAIR
MODEL NO. SSM

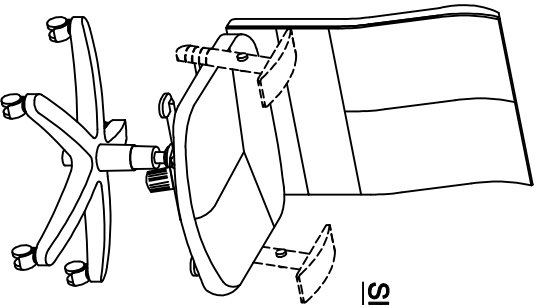





Shown with Optional Arms



IMPORTANT!
Review ALL instructions before beginning assembly. These instructions are provided to avoid problems that may occur from improper assembly or installation. Mayline and/or its distributor are not responsible for failure resulting from improper assembly or installation of this product. Moreover, all warranties are void for failure to follow these assembly instructions.

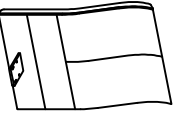

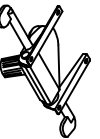

PARTS LIST SSM

When ordering components, specific color and/or size information may be required.
 Contact a Mayline Customer Service Representative. 1-800-822-8037

* Individual Items, Order by part number.
 ** Denotes Color Code

A* Reference Letter		1	Quantity
Part Number CM104** Back			
B* Reference Letter		1	Quantity
Part Number CM123** Seat			
C* Reference Letter		1	Quantity
Part Number CM160 Mechanism			
D* Reference Letter		5	Quantity
Part Number CM210 Caster (5 pack)			
E* Reference Letter		1	Quantity
Part Number CM201 Base			

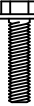
F* Reference Letter		1	Quantity
Part Number CM181 Cylinder			
G* Reference Letter		1	Quantity
Part Number CM190 Cylinder Cover			

Part Number CM218 * Hardware Pack			
H Reference Letter		2	Quantity
Screw M8 x 22mm			1 Spare
J Reference Letter		4	Quantity
Screw M8 x 27mm			1 Spare
K Reference Letter		2	Quantity
Screw M8 x 32mm			1 Spare
L Reference Letter		1	Quantity
Allen Wrench			

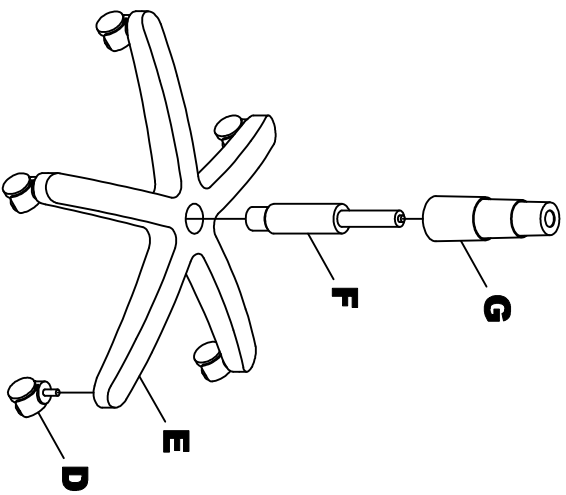

1. Place Base (E) upside down and push Casters (D) firmly into base. 5 places.
2. Turn Base right side up and insert Cylinder (F) into center hole of Base.
3. Place Cylinder Cover (G) over Cylinder.

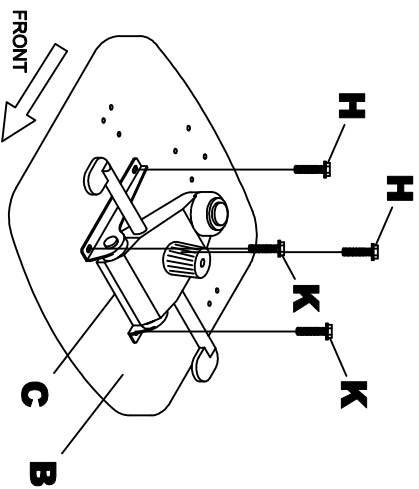

4. Assemble Mechanism (C) onto Seat (B) using Screws (H) in back of Seat.

(3)

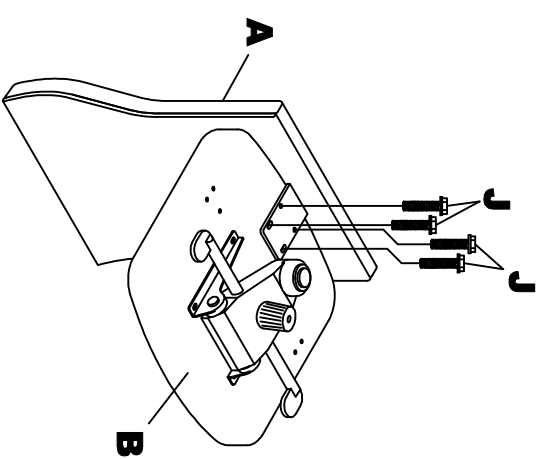

5. Assemble Back (A) onto Seat (B) using Screws (J) 4 places.

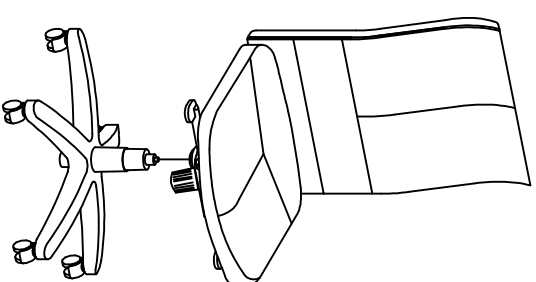

7. Carefully place chair assembly onto base assembly.

Note:
Periodically (Every 90 days) make sure screws are fully tightened.

(4)

OPERATING INSTRUCTIONS FOR DELUXE KNEE-TILT MECHANISM

1. Seat Height Adjustment.

To raise the seat, pull lever upward and raise your body up slightly to allow the chair to rise to the desired height.

To lower the seat, pull lever upward and apply weight downward on the seat.

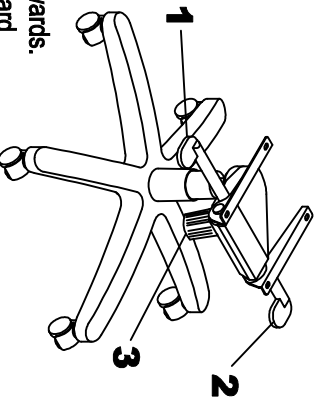

2. Seat Tilt Adjustment Lock

Pull lever upward and allow the chair to tilt backwards.

To lock to the desired position push lever downward.

To release tilt adjustment, pull lever upward, apply weight onto the back cushion and then lean forward.

3. Tilt Tension Control Knob.

Turn knob clockwise to increase tilt tension.

Turn knob counter-clockwise to decrease tilt tension.