

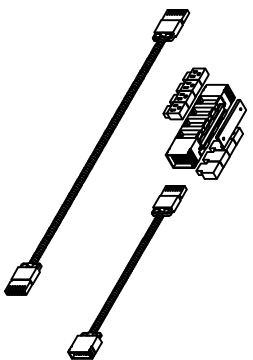

TransAction™

Double Sided Adder Workstation
Power Kits

TAETKD48AS, TAETKD60AS &
TAETKD72AS



TAETKD48AS

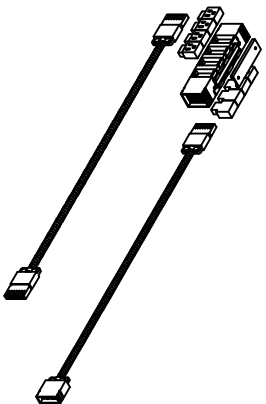

TAETKD60AS

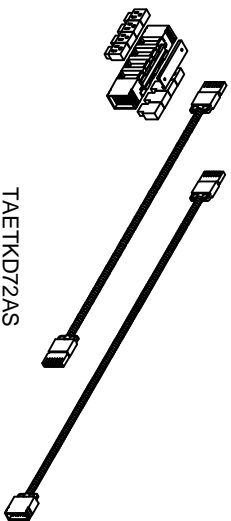

TAETKD72AS





ASSEMBLY INSTRUCTIONS

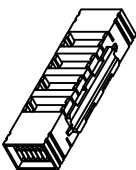
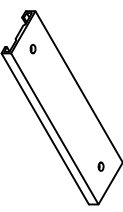

CALL 1-800-822-8037 FOR ASSISTANCE

P/N TAETKDAS 10/13/11

www.mayline.com

PARIS LISI

Name	Part	Qty.
A	 Power Block	1
B	 Mounting Bracket	1
C	 Pass Thru Cable, 12" (48" Tables)	1
	 Pass Thru Cable, 24" (60" Tables)	
	 Pass Thru Cable, 36" (72" Tables)	

Name	Part	Qty.
D	 Receptacle	8
E	 Screw #8-32 x 3/8	2
F	 Interconnecting Cable, 28"	1

IMPORTANT:
Read all instructions before beginning job. These instructions are provided to avoid problems that may occur from improper assembly. The manufacturer and/or distributor are not responsible for failure resulting from improper assembly or installation. Moreover, all warranties are void for failure to follow these assembly instructions.

1. Install mounting bracket (B) to underside of table beam using screws (E).

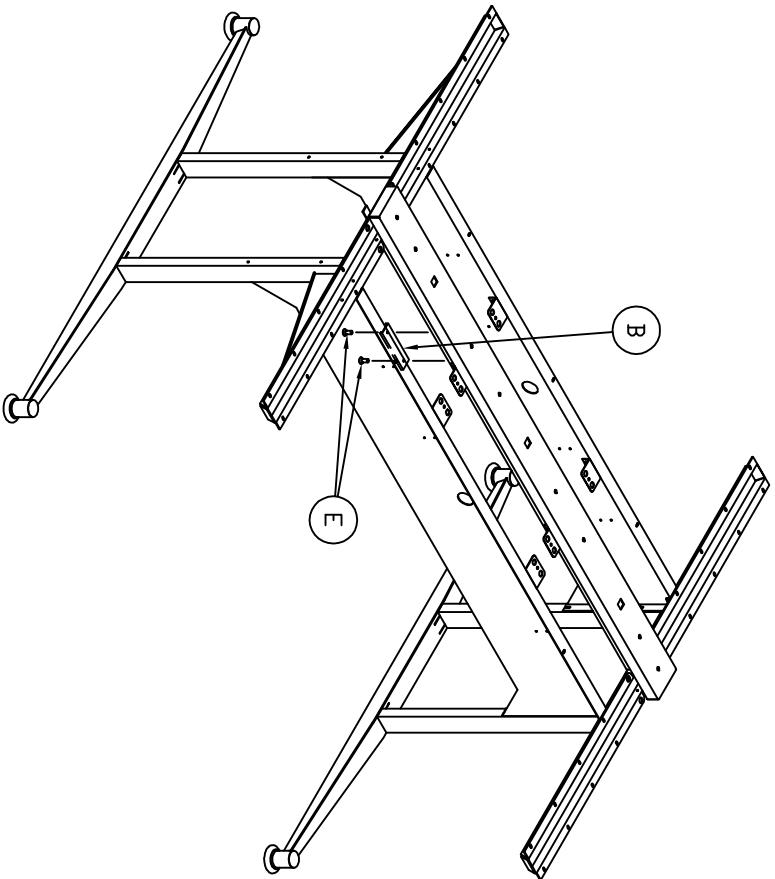

2. Snap receptacles (D) into power block (A).

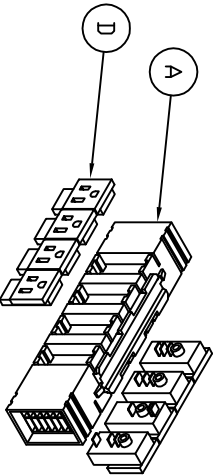

3. Slide power block (A) into mounting bracket (B).

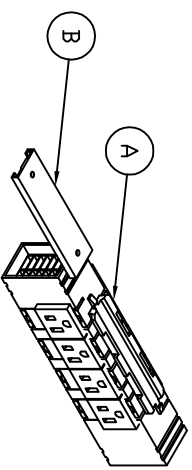

4. Connect power blocks (A) using interconnect cables (C or F).

