

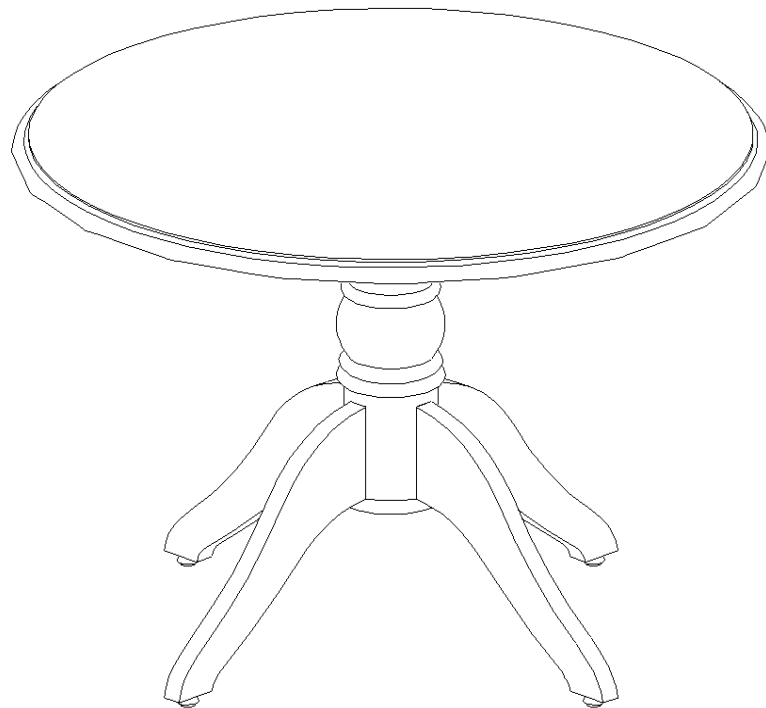

**Tiffany Industries™**  
A MAYLINE GROUP COMPANY

**Model No.TCR42**







**Round Conference Table**

**ASSEMBLY INSTRUCTIONS**

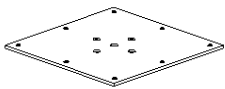
**CALL 1-800-822-8037 FOR ASSISTANCE**

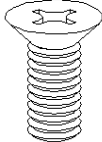
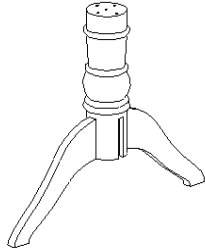
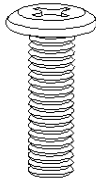
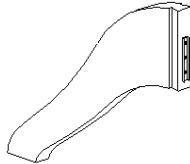
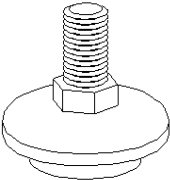
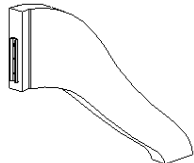
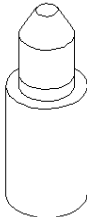
# PARTS LIST

Name	Part	Qty.	Spare Qty	Name	Part	Qty.
<b>A</b>	 S116	<b>1</b>		<b>F</b>		<b>1</b>
<b>B</b>	M6*18  S123	<b>13</b>	<b>1</b>	<b>G</b>		<b>1</b>
<b>C</b>	M6*35  S124	<b>2</b>	<b>1</b>	<b>H<sub>1</sub></b>		<b>1</b>
<b>D</b>	 S067	<b>4</b>		<b>H<sub>2</sub></b>		<b>1</b>
<b>E</b>	 S109	<b>1</b>		<b>I</b>		<b>1</b>

**1**

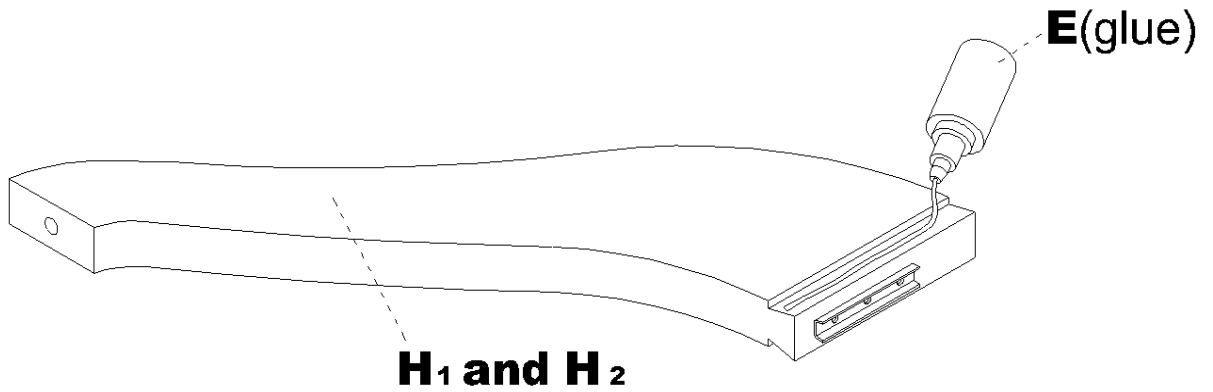

**2**

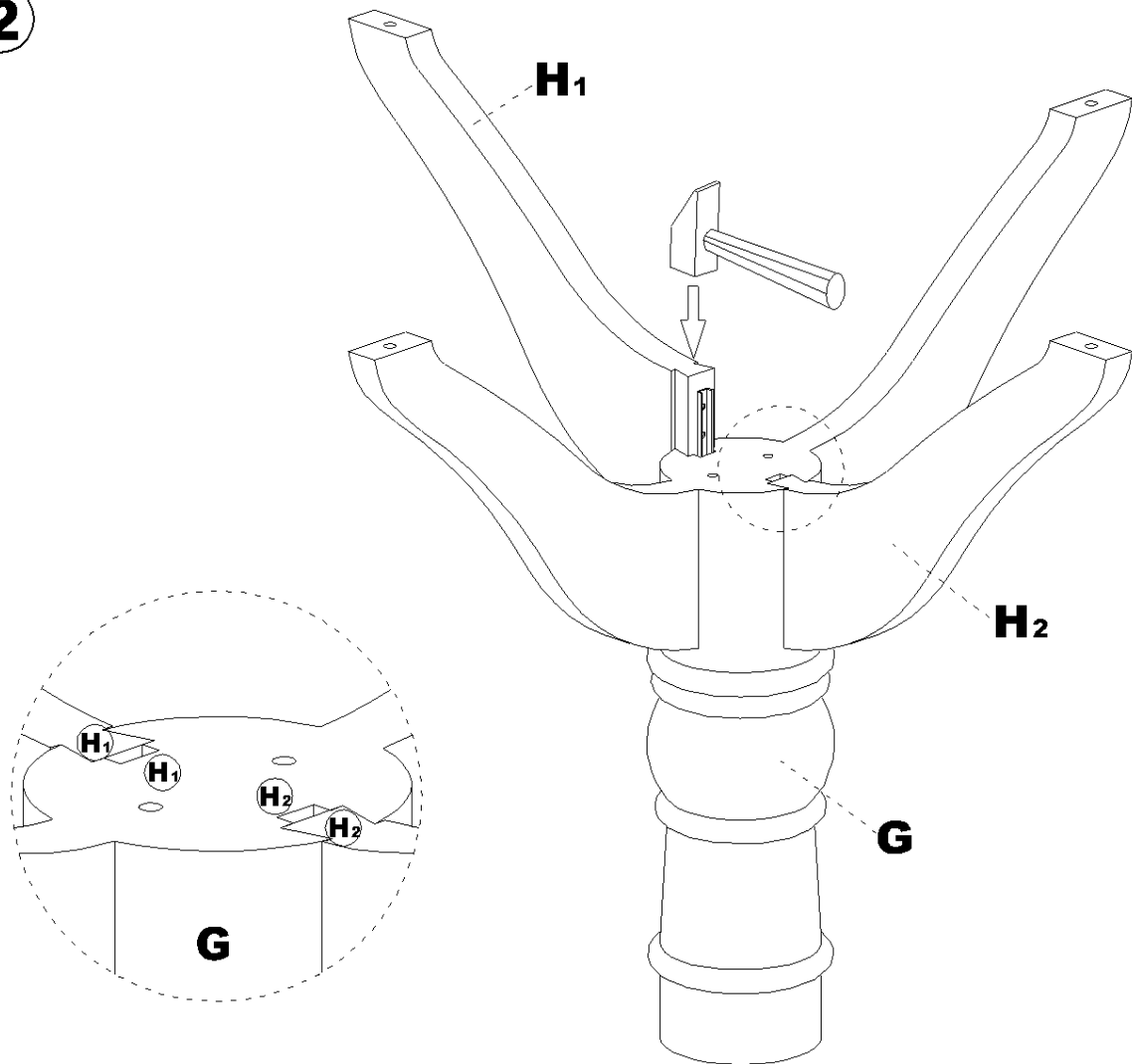

Please use a cloth to wipe off the extra glue.

**3**

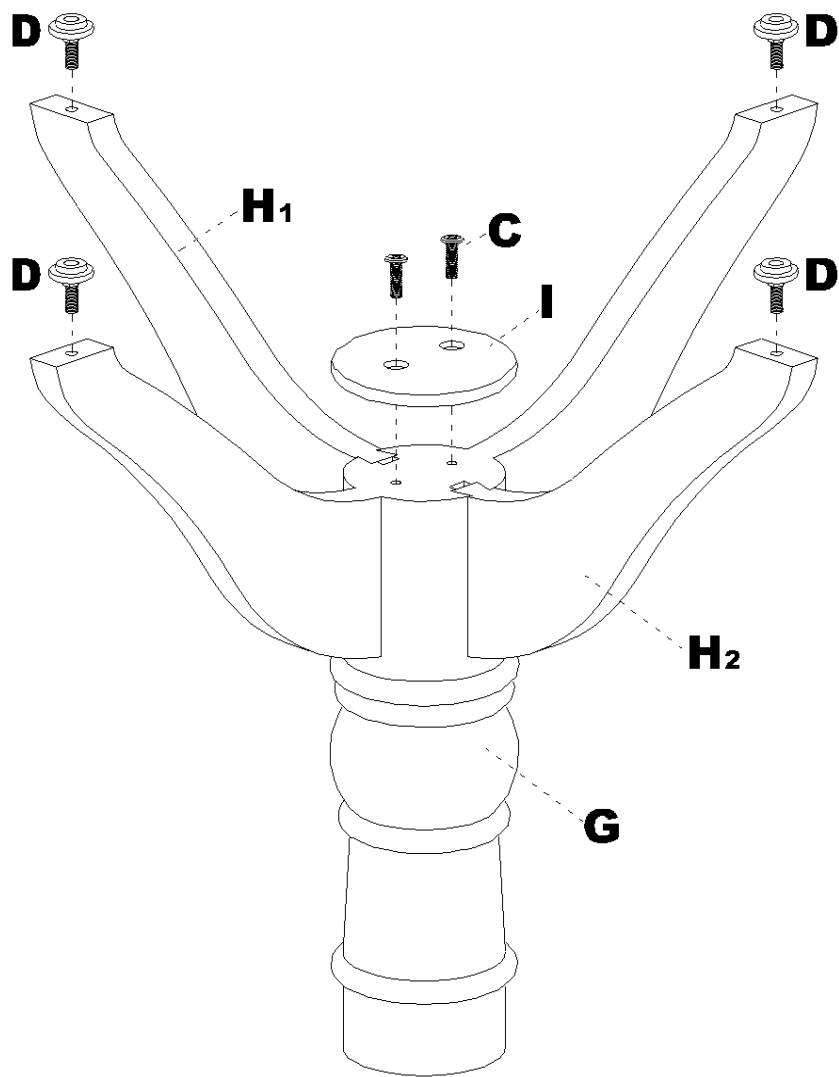

4

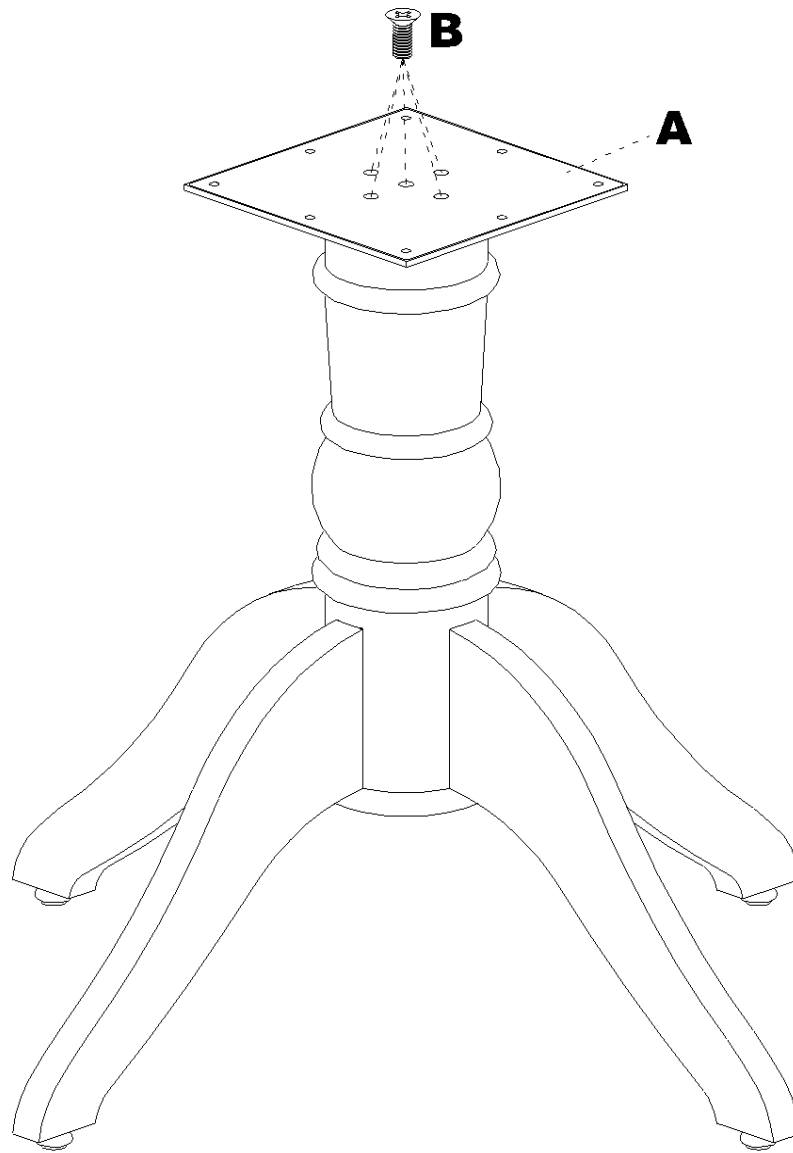

**5**

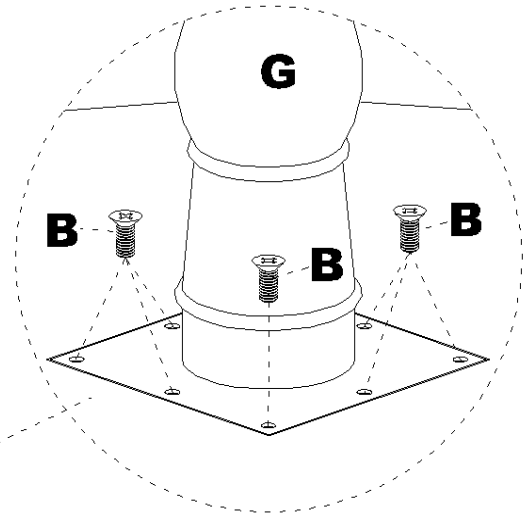

**CONTRARY(F)**

