

ASSEMBLY INSTRUCTIONS

Mercado Mesh Back Chair

Model No. 3200/3200G



IMPORTANT!

Review ALL instructions before beginning assembly. These instructions are provided to avoid problems that may occur from improper assembly or installation. Mayline and/or its distributor are not responsible for failure resulting from improper assembly or installation of this product. Moreover, all warranties are void for failure to follow these assembly instructions.











P/N 3200 REV 06 08/28/2017

PARTS LIST 3200/3200G



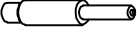

When ordering components, specific color and/or size information may be required. Contact a Mayline Customer Service Representative. 1-800-822-8037

* Individual Items, Order by part number.

** Denotes Color Code.

Reference Letter A		Quantity 1
Back		
Reference Letter B		Quantity 1
Seat		
Reference Letter C*	3200AP** Arm Pad 	Quantity 2
Part Number 3200ARMS** Arms (pair)		
Reference Letter D		Quantity 1
Mechanism		
Reference Letter E*		Quantity 5
Part Number 101725** Caster (5 per pack)		
Reference Letter F		Quantity 1
Base		
Reference Letter G*		Quantity 1
Part Number 3200GC** Cylinder		
Reference Letter H		Quantity 1
Cylinder Cover		

Reference Letter J		Quantity 2
Arm Knob		

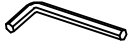
Part Number * 101704 Hardware Bag			
Reference Letter		Quantity	Spare
K		3	1
Screw M8 x 18mm			
Reference Letter L		4	1
Screw M6 x 30mm			
Reference Letter M		3	1
Washer			
Reference Letter N		7	1
Lock Washer			
Reference Letter P		4	1
Washer			
Reference Letter R		1	
Allen Wrench			

1

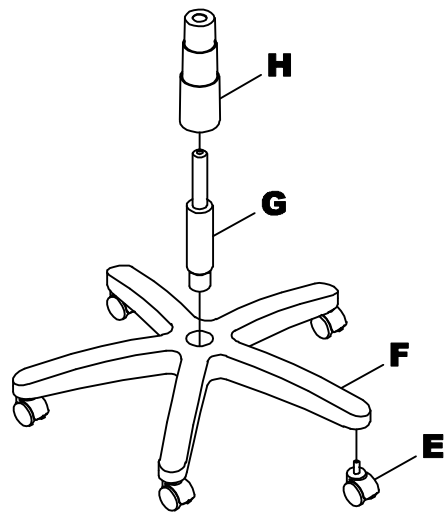

1. Place Base (F) upside down and push Casters (E) firmly into base. 5 places.
2. Turn Base right side up and insert Cylinder (G) into center hole of Base.
3. Place Cylinder Cover (H) over Cylinder.

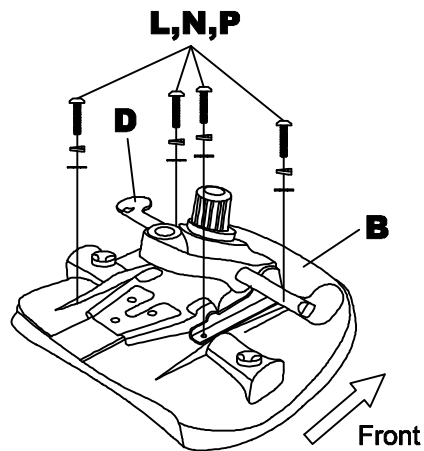

4. Assemble Mechanism (D) to Seat (B) using Screws (L), Lock Washer (N) & Washer (P) 4 places as shown.

2

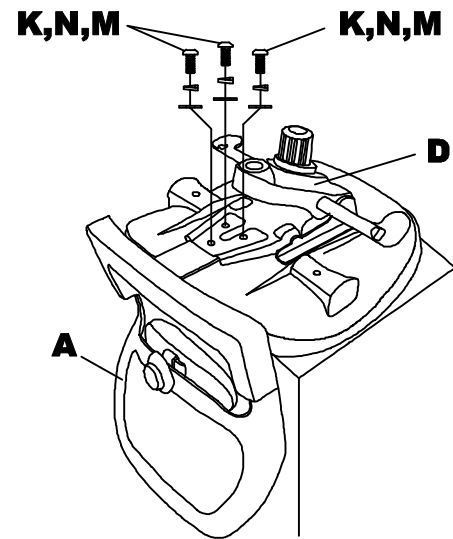

5. Assemble Back (A) onto Mechanism (D) using Screws (K), Lock Washer (N) & Washer (M) 3 places as shown.

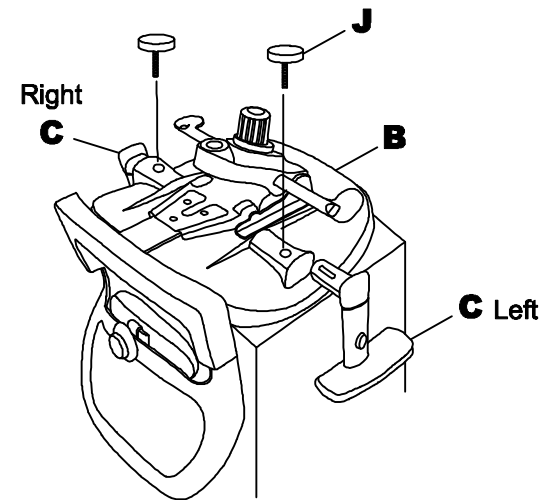

4. Assemble Arms (C) 2 places onto Seat (B) using Knobs (J) 1 place each arm.

3



6. Carefully place chair assembly onto base assembly.

NOTE:

Periodically (Every 90 days) make sure screws are fully tightened.

OPERATING INSTRUCTIONS FOR SYNCHRO-TILT MECHANISM

Synchro-Tilt allows the back to tilt 2 degrees for every 1 degree of seat tilt.

1. Seat Height Adjustment.

To raise the seat, pull lever upward and raise your body up slightly to allow the chair to rise to the desired height.

To lower the seat, pull lever upward and apply weight downward on the seat.

2. Seat Tilt Adjustment Lock

Pull lever upward and allow the chair to tilt backwards.

To lock to the desired position push lever downward.

To release tilt adjustment, pull lever upward, apply weight onto the back cushion and then lean forward.

3. Tilt Tension Control Knob.

Turn knob clockwise to increase tilt tension.

Turn knob counter-clockwise to decrease tilt tension.

