

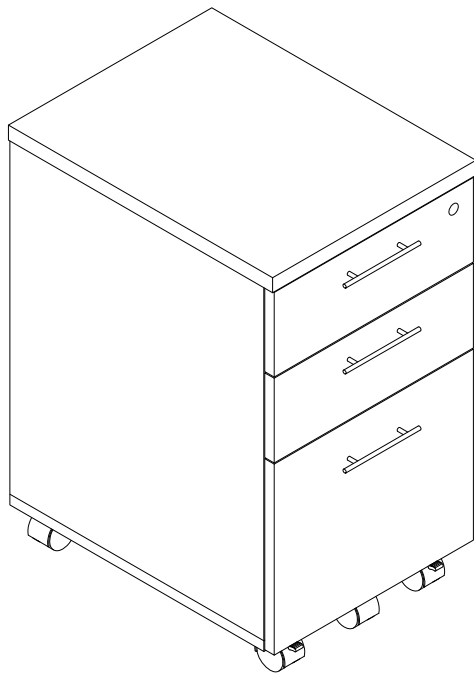





Medina Series™
 Mobile Pedestal, Box/Box/File
 Model No. MNBBF

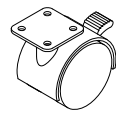
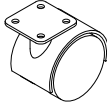
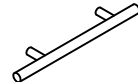

ASSEMBLY INSTRUCTIONS
 CALL 1-800-822-8037 FOR ASSISTANCE

PARTS LIST

Name	Part	Qty.	Spare Qty	Name	Part	Qty.	Spare Qty
A	 REALS005 4x16mm	20	1	D	 REALS052 Caster	2	
B	 REALS027* Caster	3		E	 REALS410 Handle-96mm Center	3	
C	 Keys	1		F	 REALS249 Handle Screw-M4x33mm	6	

*Note: For replacement caster(s) use REALS052

IMPORTANT!

Review ALL instructions before beginning assembly. These instructions are provided to avoid problems that may occur from improper assembly or installation. Mayline and/or its distributor are not responsible for failure resulting from improper assembly or installation of this product. Moreover, all warranties are void for failure to follow these assembly instructions.

Items with HB are in hardware box.

① Attach Handles (E) to the fronts of Drawer using Screws (F)

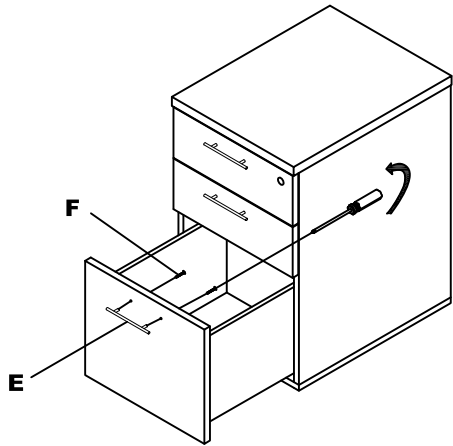

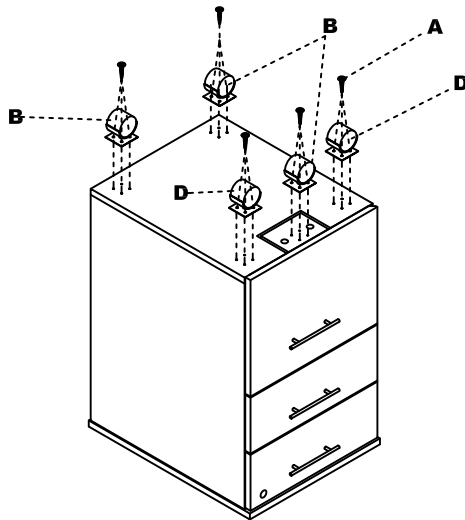

② Attach Casters (B & D) to underside of Pedestal using Screws (A).

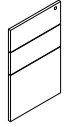

2

Pre-Installed Replacement Parts List

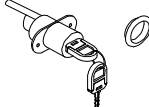
Part	Included Qty.	Part	Included Qty.
 MNBBDF** Drawer Fronts, Set of 3	1	 REALS054 16" Drawer Slides	3
 REALS401 Lock w/ Key	1		

**Denotes Color Code

3