

**MAYLINE**

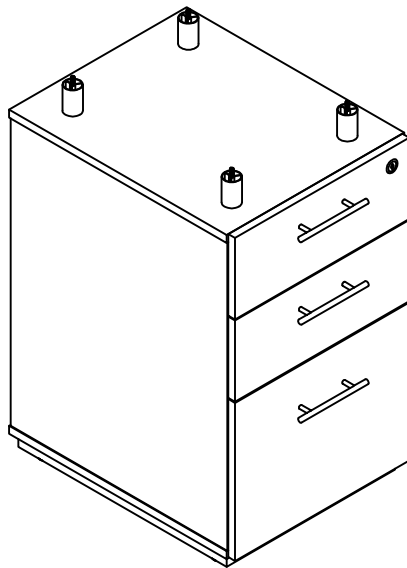







**Sterling Series™**  
**Credenza Pedestal Box / Box / File**  
**Model No. STCBBF**

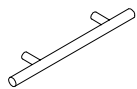

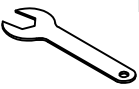
**ASSEMBLY INSTRUCTIONS**

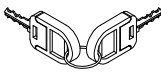
**CALL 1-800-822-8037 FOR ASSISTANCE**

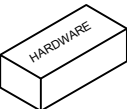
**PARTS LIST**

Name	Part	Qty.	Spare Qty	Name	Part	Qty.	Spare Qty
<b>A</b>	 <b>REALS410</b> Handle-96mm Center	<b>3</b>		<b>F</b>	 <b>REALS638</b> M6 Flange Nut	<b>4</b>	<b>1</b>
<b>B</b>	 <b>REALS249</b> Handle Screw-M4x33mm	<b>4</b>	<b>1</b>	<b>G</b>	 <b>REALS639</b> 10mm Wrench	<b>1</b>	
<b>C</b>	 <b>REALS045</b> Handle Screw-M4x25mm	<b>2</b>	<b>1</b>	<b>H</b>	 <b>Keys</b>	<b>1</b>	
<b>D</b>	 <b>REALS607</b> Ø32*50mm Base Stand-off	<b>4</b>			 <b>STCBBFHB</b>		
<b>E</b>	 <b>REALS637</b> M6 x 35mm	<b>4</b>	<b>1</b>				

Items with HB are in hardware box.

## IMPORTANT!

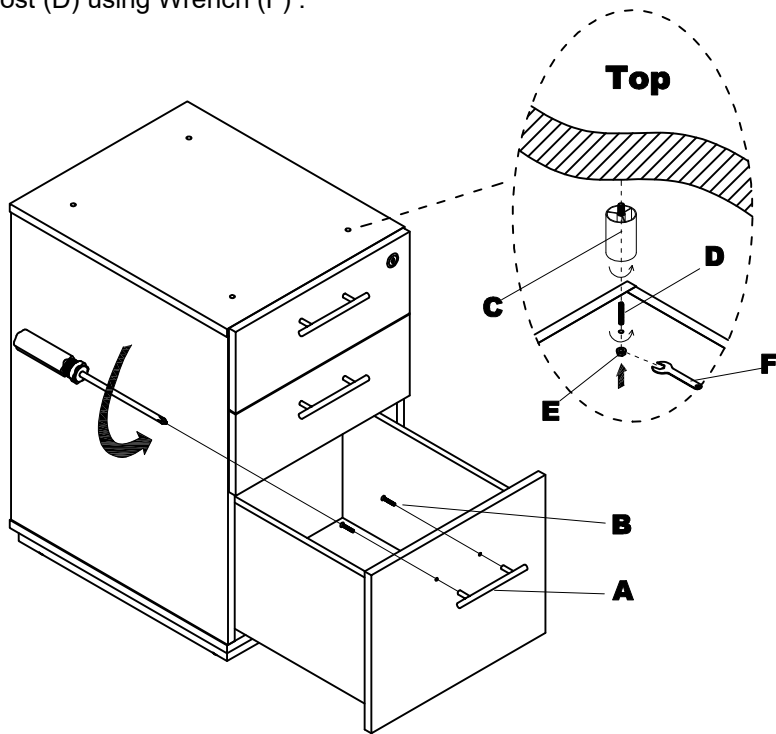

**Review ALL instructions before beginning assembly.** These instructions are provided to avoid problems that may occur from improper assembly or installation. Mayline and/or its distributor are not responsible for failure resulting from improper assembly or installation of this product. Moreover, all warranties are void for failure to follow these assembly instructions.

- 1** Attach Handles (A) to the Fronts of Drawer using Screws (B). Attach the Stand-offs (C) to the Bottom of TOP. Thread Post (D) into bottom of Stand-offs (C). Once Top is in place, tighten Nut (E) on Post (D) using Wrench (F) .

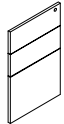

**2**

## Pre-Assembled Replacement Part List

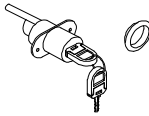
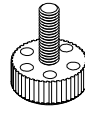
Part	Included Qty.	Part	Included Qty.
 <b>STCBBFDF**</b> Drawer Fronts, Set of 3	<b>1</b>	 <b>REALS054</b> 16" Drawer Slides	<b>3</b>
 <b>REALS401</b> Lock w/ Key	<b>1</b>	 <b>REALS425</b> Leveler	<b>4</b>

\*\*Denotes Color Code

**3**