

MAYLINE

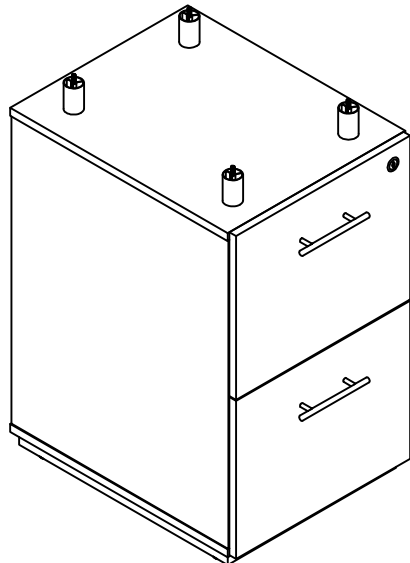





Sterling Series™
Credenza Pedestal, File/File
Model No. STCFF

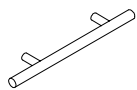

ASSEMBLY INSTRUCTIONS

CALL 1-800-822-8037 FOR ASSISTANCE

PARTS LIST

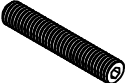
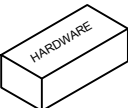
Name	Part	Qty.	Spare Qty	Name	Part	Qty.	Spare Qty
A	 REALS410 Handle-96mm Center	2		E	 REALS638 M6 Flange Nut	4	1
B	 REALS249 Handle Screw-M4x33mm	4	1	F	 REALS639 10mm Wrench	1	
C	 REALS607 Ø32*50mm Base Stand-off	4		G	 Keys	1	
D	 REALS637 M6 x 35mm	4	1		 STCFFHB		

Items with HB are in hardware box.

IMPORTANT!

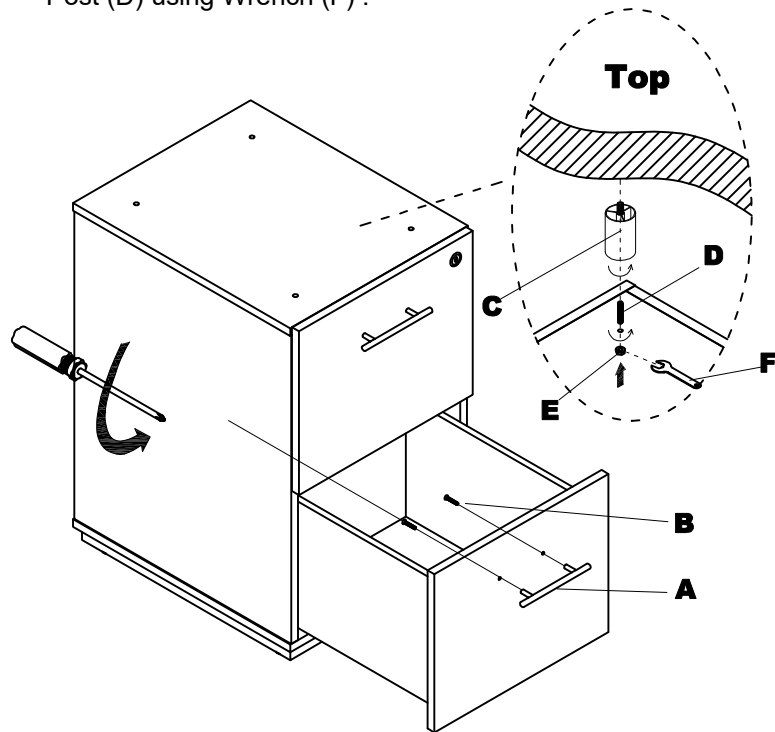

Review ALL instructions before beginning assembly. These instructions are provided to avoid problems that may occur from improper assembly or installation. Mayline and/or its distributor are not responsible for failure resulting from improper assembly or installation of this product. Moreover, all warranties are void for failure to follow these assembly instructions.

- 1 Attach Handles (A) to the Fronts of Drawer using Screws (B). Attach the Stand-offs (C) to the Bottom of TOP. Thread Post (D) into bottom of Stand-offs (C). Once Top is in place, tighten Nut (E) on Post (D) using Wrench (F) .

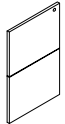

2

Pre-Assembled Replacement Part List

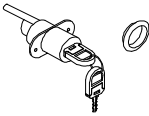
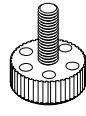
Part	Included Qty.	Part	Included Qty.
 STCFFDF** Drawer Fronts, Set of 2	1	 REALS054 16" Drawer Slides	2
 REALS401 Lock w/ Key	1	 REALS425 Leveler	4

**Denotes Color Code

3