

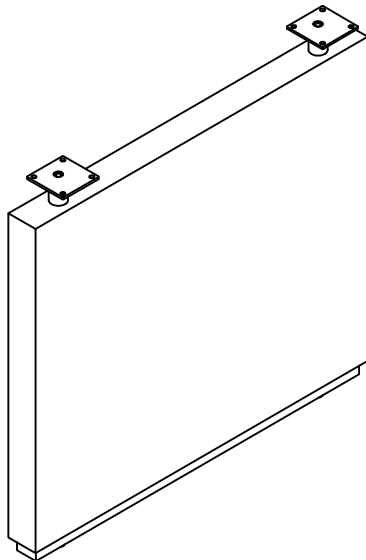







Sterling Series™
48" Bridge Base
Model No. STEB48





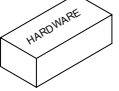

ASSEMBLY INSTRUCTIONS

CALL 1-800-822-8037 FOR ASSISTANCE

PARTS LIST

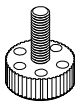
Name	Part	Qty.	Spare Qty	Name	Part	Qty.	Spare Qty
A	 REALS603 M6x15mm	40	2	D	 REALS608 Mounting Plate	4	
B	 REALBY028 Wrench 4mm	1		E	 STEB48** leg	1	
C	 REALS084 Wrench 5mm	1			 STEBHB		

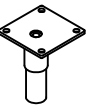
Pre-Assembled Replacement Part List

Replacement #	Part	Qty.	Replacement #	Part	Qty.
REALS425	 Leveler	2	REALS601	 Screw	2
REALS602	 Base Stand-off	2	REALS644	 Base Stand-off Ø34x43mm	2

Items with HB are in hardware box.

**Denotes Color Code

IMPORTANT!

Review ALL instructions before beginning assembly. These instructions are provided to avoid problems that may occur from improper assembly or installation. Mayline and/or its distributor are not responsible for failure resulting from improper assembly or installation of this product. Moreover, all warranties are void for failure to follow these assembly instructions.

- 1 Attach Mounting Plate (D) to the underside of adjacent Top (STET48) using Screws (A) and Wrench (B). Attach Leg (E) to the underside of adjacent Top (STET48) using Screws and Wrench(B).

