

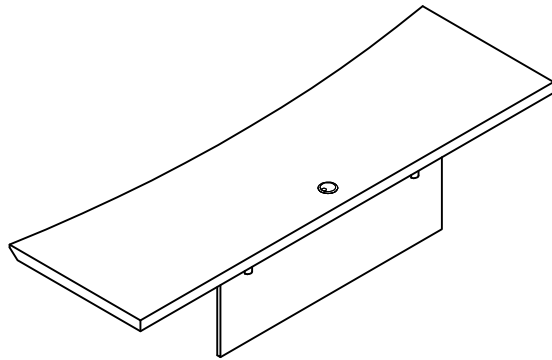







Sterling Series™
Credenza 72"
Model No. STECT72

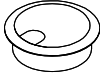

ASSEMBLY INSTRUCTIONS

CALL 1-800-822-8037 FOR ASSISTANCE

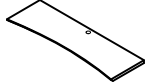
PARTS LIST

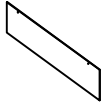
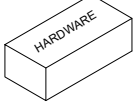
Name	Part	Qty.	Spare Qty	Name	Part	Qty.	Spare Qty
A	 REALS604 Round Clamp	2		D	 REALS100 Grommet	1	
B	 REALS605 M6x20mm	2	1	E	 STECT72** Top	1	
C	 REALBY028 Wrench	1		F	 STECTF** Modesty Panel	1	
	 STECTHB						

Items with HB are in hardware box.

**Denotes Color Code

IMPORTANT!

Review ALL instructions before beginning assembly. These instructions are provided to avoid problems that may occur from improper assembly or installation. Mayline and/or its distributor are not responsible for failure resulting from improper assembly or installation of this product. Moreover, all warranties are void for failure to follow these assembly instructions.

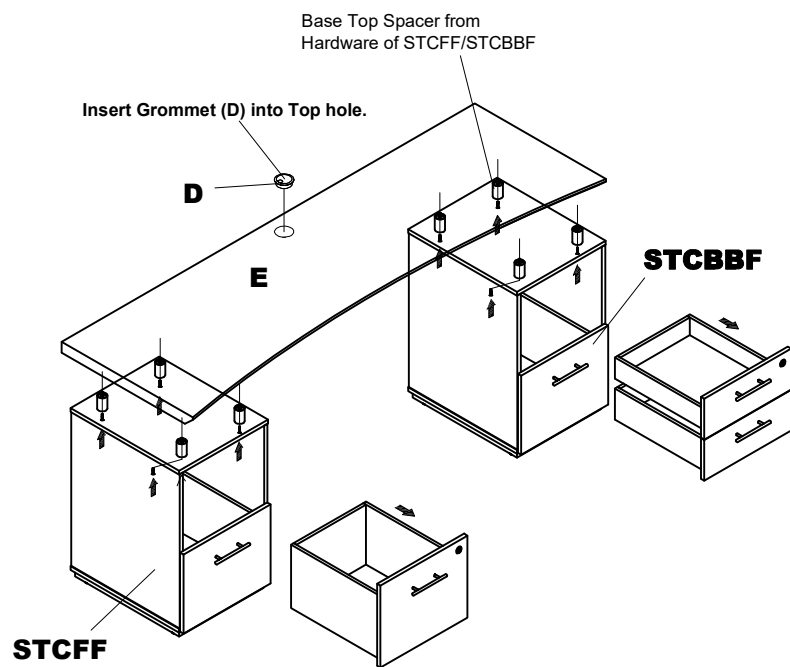

2

- 1 Install Round Clamp (A) into the Bottom of Top for STECT72.

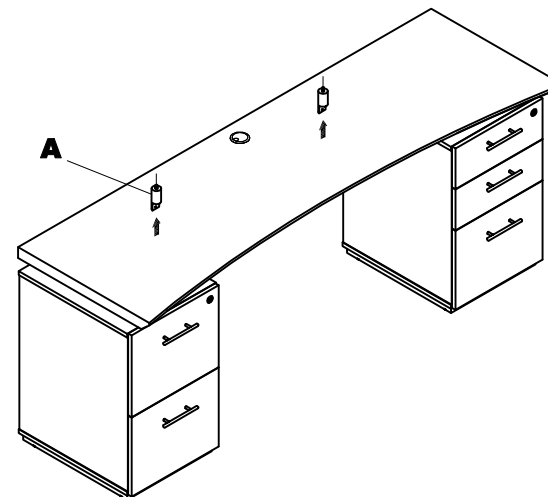

- 2 Install the Modesty Panel (F) by Round Clamp (A) and Screws (B).

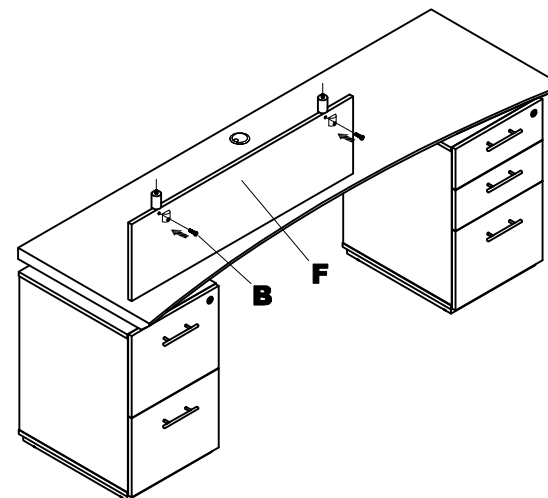

3