

ASSEMBLY INSTRUCTIONS

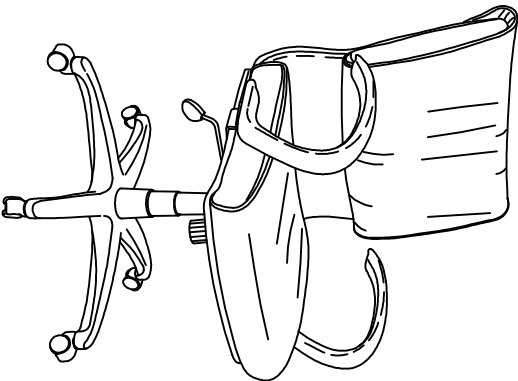



**MERCADO SERIES
MID-BACK CHAIR
MODEL NO. 2547**





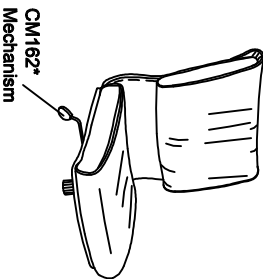

PARTS LIST 2547

When ordering components, specific color and/or size information may be required. Contact a Mayline Customer Service Representative. 1-800-822-8037

* Individual Items, Order by part number.
** Denotes Color Code

Reference Letter A*		Quantity 1
Part Number CM110** Back/Seat		
Reference Letter B*		Quantity 1
Part Number CM148 Arms (pair)		
Reference Letter C*		Quantity 5
Part Number CM210 Caster (5 pack)		
Reference Letter D*		Quantity 1
Part Number CM202 Base		

Reference Letter E*		Quantity 1
Part Number CM473 Cylinder		
Reference Letter F*		Quantity 1
Part Number CM191 Cylinder Cover		

Part Number CM450* Hardware Pack			
Reference Letter G		Quantity 6	Spare 1
Reference Letter H		Quantity 1	

IMPORTANT!

Review ALL instructions before beginning assembly. These instructions are provided to avoid problems that may occur from improper assembly or installation. Mayline and/or its distributor are not responsible for failure resulting from improper assembly or installation of this product. Moreover, all warranties are void for failure to follow these assembly instructions.



MAYLINE

Mayline Company, LLC
619 N. Commerce, P.O. Box 728
Sheboygan, WI 53082-0728
Toll Free: 1-800-822-8037
FAX: 920-457-7388
On Line: www.mayline.com

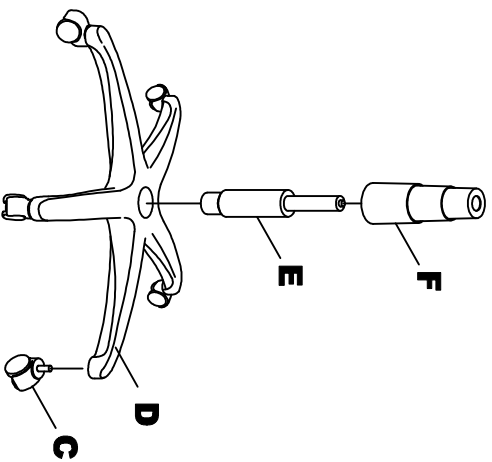

1. Place Base (D) upside down and push Casters (C) firmly into base. 5 places.
2. Turn Base right side up and insert Cylinder (E) into center hole of Base.
3. Place Cylinder Cover (F) over Cylinder.

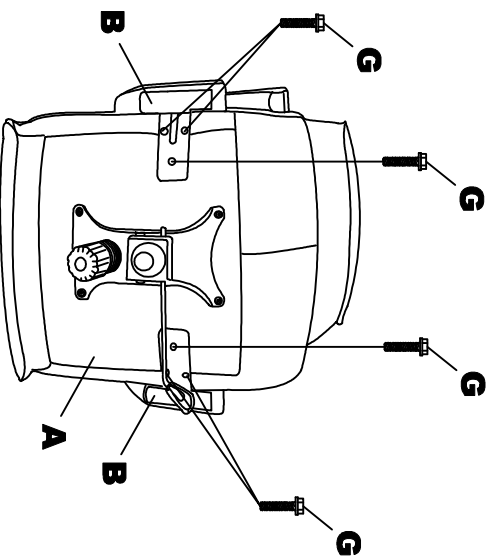

4. Assemble Arms (B) 2 places onto Seat (A) using Screws (G) 6 places.

(3)

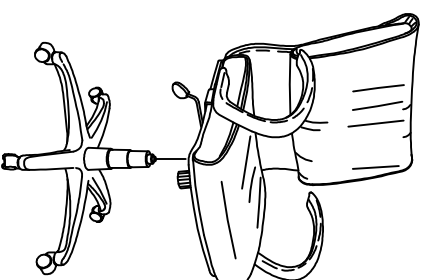

5. Carefully place chair assembly onto base assembly.

NOTE:

Periodically (Every 90 days) make sure screws are fully tightened.

OPERATING INSTRUCTIONS FOR CENTER PIVOT (BUTTERFLY) MECHANISM

1. Seat Height Adjustment.

To raise the seat, pull lever upward and raise your body up slightly to allow the chair to rise to the desired height.

To lower the seat, pull lever upward and apply weight downward on the seat.

Seat Upright Lock

To lock chair in upright position, lean forward and push knob toward chair.

To unlock chair in upright position, lean forward and pull knob away from chair.

2. Tilt Tension Control Knob.

Turn knob clockwise to increase tilt tension.

Turn knob counter-clockwise to decrease tilt tension.

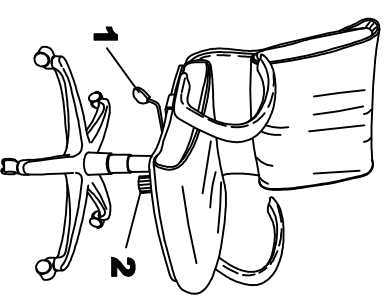

(4)