

# ASSEMBLY INSTRUCTIONS

## TRANSACTION 10' CONFERENCE TABLE



















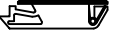

**NOTE:** Please count and inspect all pieces before disposing of any carton or packing materials.

**COMPONENTS:** When ordering components, specific color and/or size information may be required. Contact a Mayline Customer Service Representative. 1-800-822-8037

Item #	QTY.	DESCRIPTION	PART #	Item #	QTY.	DESCRIPTION	PART #
1	4	LEG	A8073**	7	2	CENTER ACCESS PANEL	B8311**
2	2	PANEL ASSEMBLY	TACEP**	8	2	INNER LEG PANEL 14.35"	B8299**
3	2	SPREADER	B8304**	9	1	R.H. CONNECTOR PANEL	B8312
4	1	TROUGH ASSEMBLY	A8075**	10	1	L.H. CONNECTOR PANEL	B8313
5	1	WORKSURFACE	<b>CALL</b> **	11	1	GROMMET	F787BK
6	4	OUTSIDE ACCESS PANEL	B8308**	12	1	WIRE COVER	F784G

\*\* Denotes Color Code

### HARDWARE BAG (PART No. A8081) \* for individual item, order that part number

Item #	QTY	DESCRIPTION	PART #		
E1	4	TUBE INSERT, 5/16-18	T139*		
E2	4	GLIDE	Q608*		
E3	4	GLIDE	Q630*		
E4	30	SCREWS #10-32 x 1/2"	X204*		
E5	28	SCREW #10 x 3/4	X11*		
E6	2	SLAM LATCH	Q643*		
E7	12	SLAM LATCH	Q624*		
E8	4	FELT PAD	E518*		
E9	4	STAND OFF	B8415*		
E10	2	SCREW #6 x 1	X14*		

1. Install threaded inserts (E1) into legs
2. Thread glides (E2) into threaded inserts installed in Step 1.
3. Thread glides (E3) into bottom of panel assembly.
4. Attach legs (1) to panel assembly (2) with screws (E4).

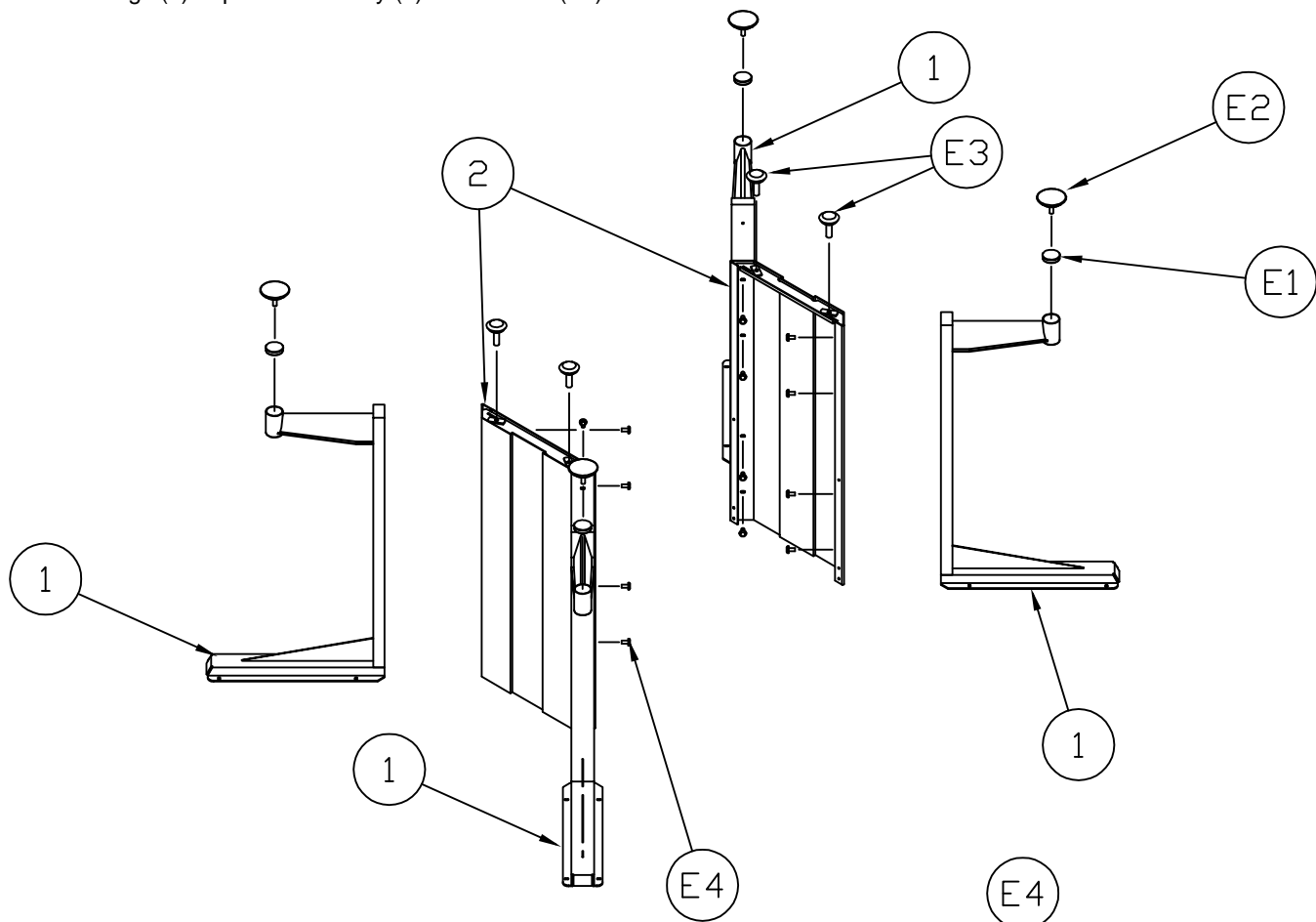

5. Partially install screws (E4) into the bottom hole of each leg assembly so that the screw head is approximately 1/8" from the leg.
6. Using the key hole slots in the ends of the trough assembly (4), attach trough to leg assemblies. **DO NOT TIGHTEN SCREWS AT THIS TIME.**
7. Install spreader (3) between leg assemblies using screws (E4).
8. Tighten screws (E4) for trough (4) and spreaders (3).

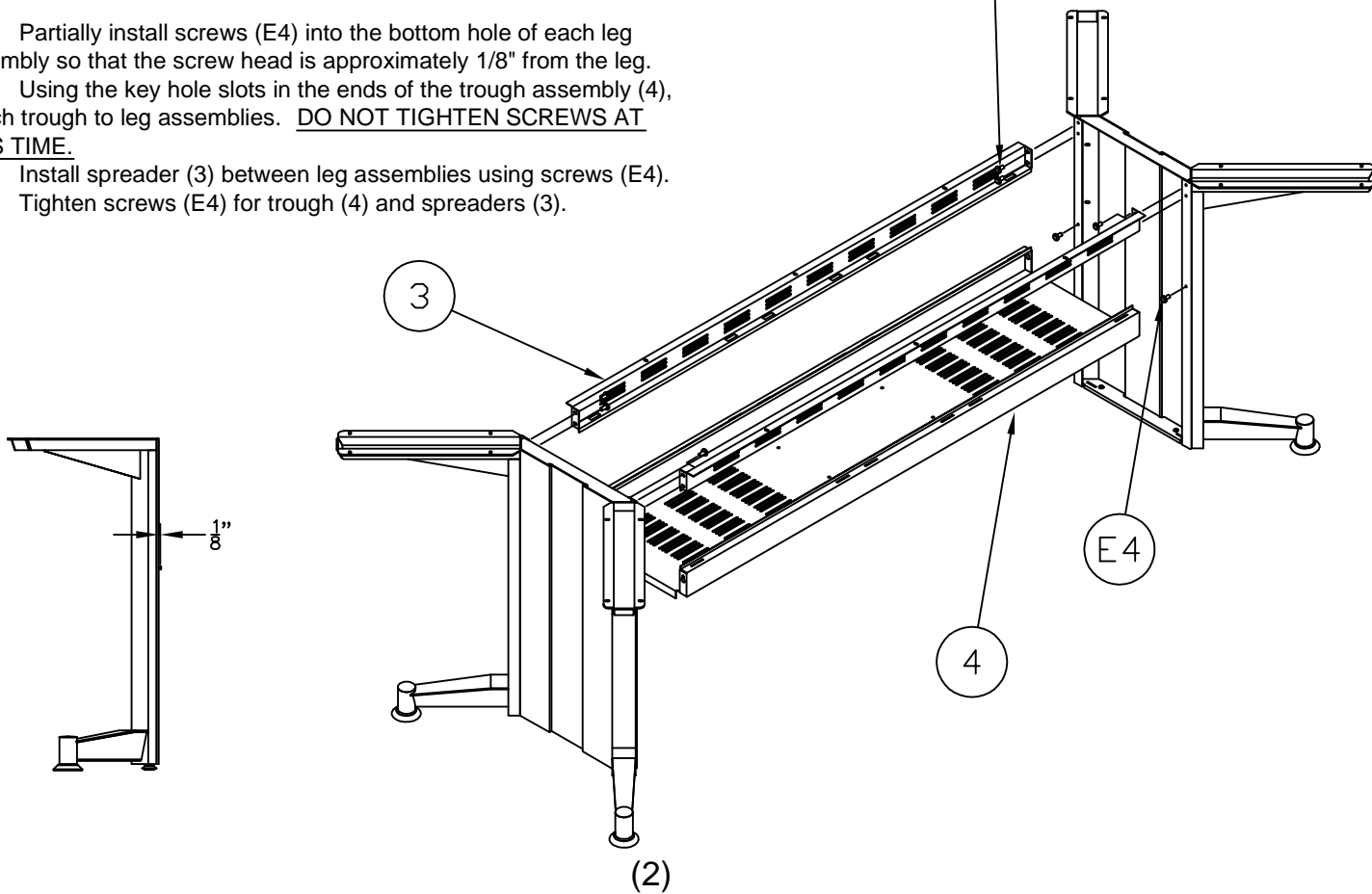

9. Position Connector panels (9 & 10) as shown in detail. Attach Connector Panels (9 & 10) to trough assembly using screws (E4).

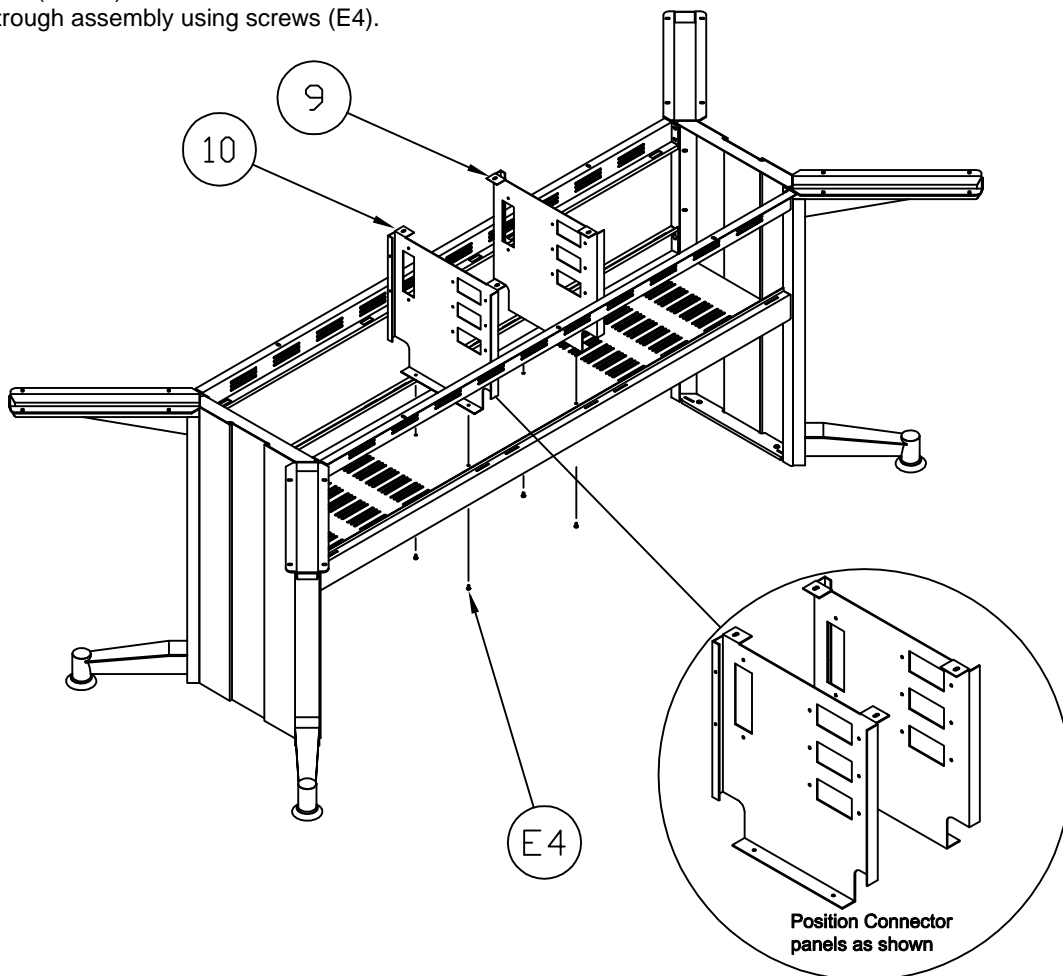

10. Install slam latch (E6) into inner leg panel slot (8) as shown.

11. Insert inner leg panel tables (8) into leg panel slots. Rotate inner leg panel till slam latch catches trough assembly (4).

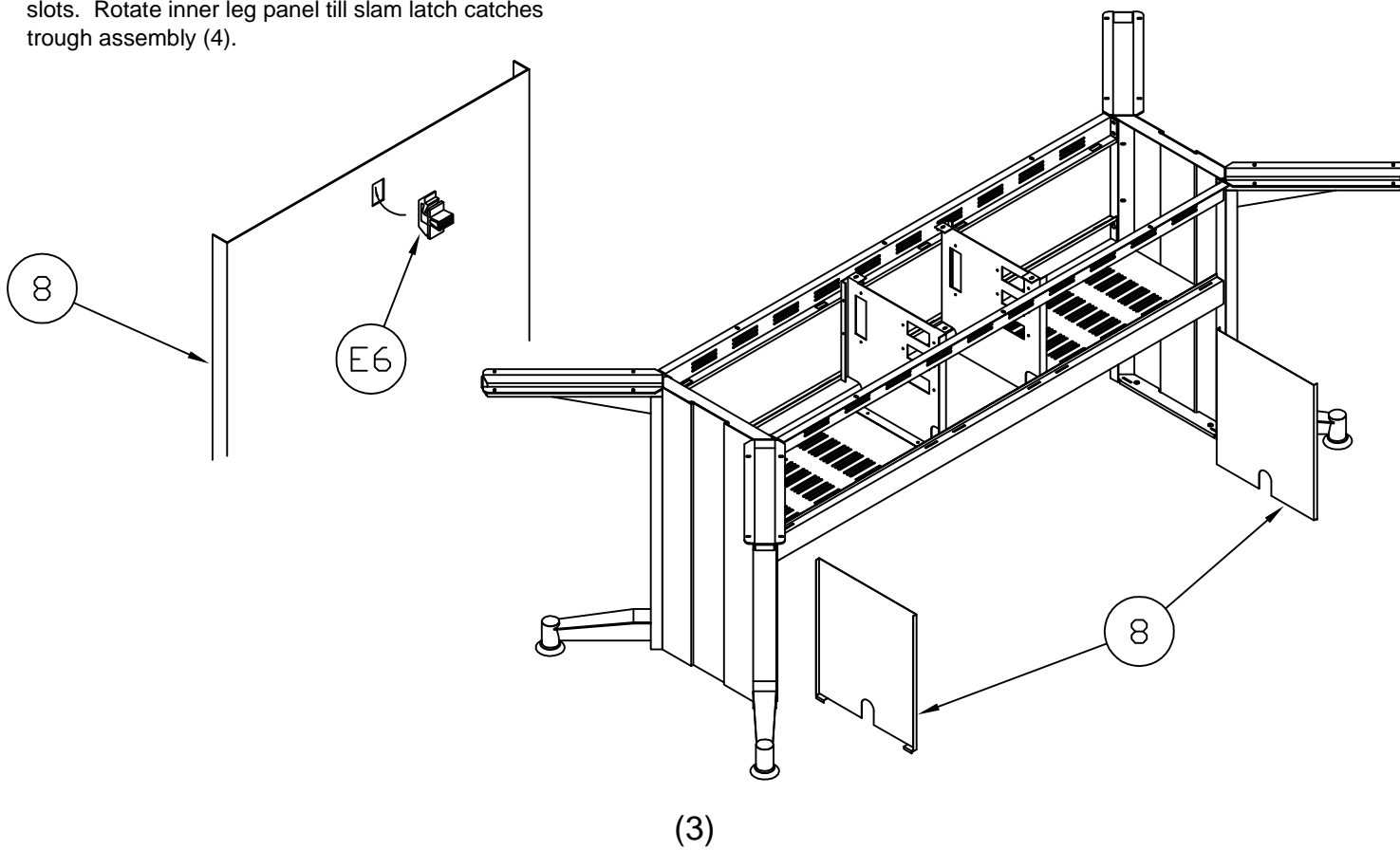

12. Position worksurface on base assembly and fasten using screws (E5) through legs, spreader and connector panels.
13. Insert slam latch (E7) into access panels (6 & 7).
14. Install the access panels into the table base by inserting panel tabs in access panels (6 & 7) into trough (4) slots. Pivot panels up until latch catches on spreader.

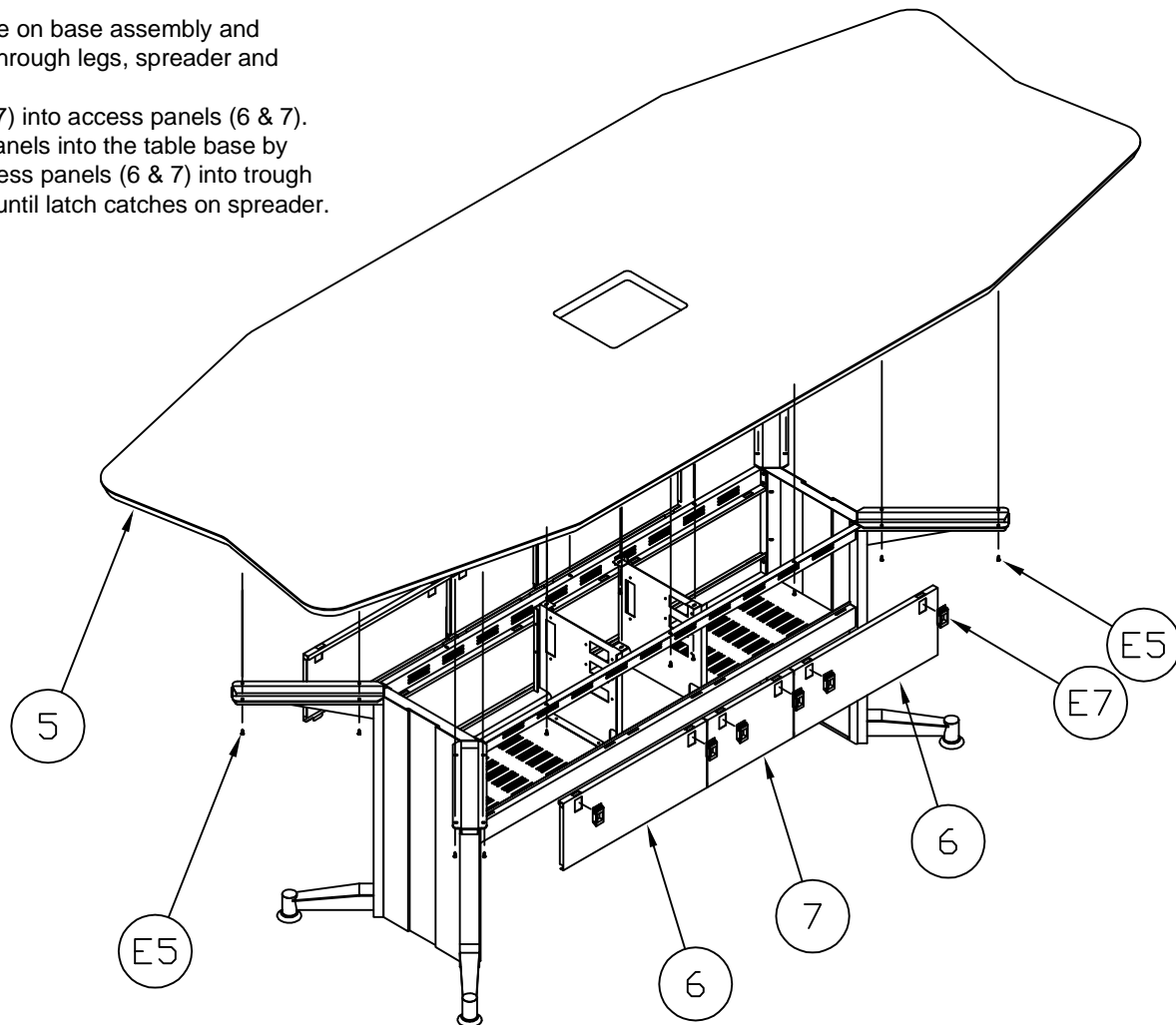

15. Insert grommet (11) into hole in worksurface (5) and fasten using screws (E10).
16. Attach standoffs (E9) to wire cover (12).
17. Adhere felt pads (E8) to the bottom of standoffs (E9).

