

ASSEMBLY INSTRUCTIONS

TRANSACTION BASIC

CONFERENCE TABLE

NOTE: Please count and inspect all pieces before disposing of any carton or packing materials.

COMPONENTS: When ordering components, specific color and/or size information may be required. Contact a Mayline Customer Service Representative. 1-800-822-8037

8' CONFERENCE TABLE













Item #	QTY.	DESCRIPTION	PART #
1	4	LEG	A8073**
2	2	PANEL ASSEMBLY	TABEP**
3	2	SIDE PANEL	B8413 **
4	1	WORKSURFACE	CALL**
5	2	INNER LEG PANEL	B8299**

10' CONFERENCE TABLE

Item #	QTY.	DESCRIPTION	PART #
1	4	LEG	A8073**
2	2	PANEL ASSEMBLY	TABEP**
3	2	SIDE PANEL	B8390 **
4	1	WORKSURFACE	CALL**
5	2	INNER LEG PANEL	B8299**

** Denotes Color Code

HARDWARE BAG (PART No. A8126) * for individual item, order that part number

Item #	QTY	DESCRIPTION	PART #		
E1	4	TUBE INSERT, 5/16-18	T139*		
E2	4	GLIDE	Q608*		
E3	4	GLIDE	Q630*		
E4	26	SCREWS #10-32 x 1/2"	X204*		
E5	24	SCREW #10 x 3/4	X11*		
E6	2	SLAM LATCH	Q643*		

1. Install threaded inserts (E1) into legs (1).
2. Thread glides (E2) into threaded inserts installed in Step 1.
3. Thread glides (E3) into bottom of panel assembly (2).
4. Attach legs (1) to panel assembly (2) with screws (E4).

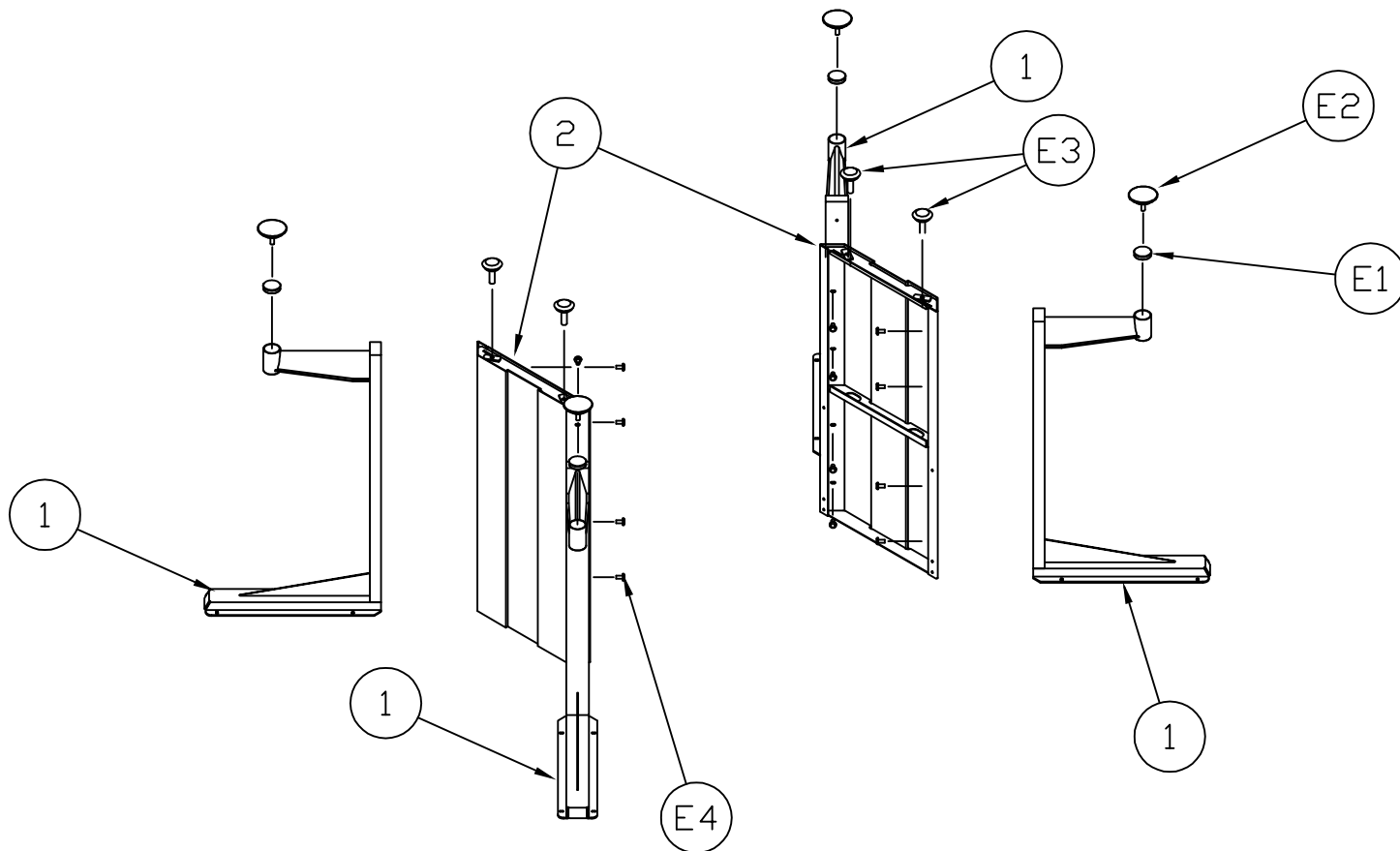

5. Partially install screws (E4) into the second hole from the top and the bottom holes of each leg panel assembly so that the screw heads are approximately 1/8" from the leg.
6. Using the slots in the ends of the side panels (3), attach side panels to leg assemblies. TIGHTEN ALL SCREWS AT THIS TIME.

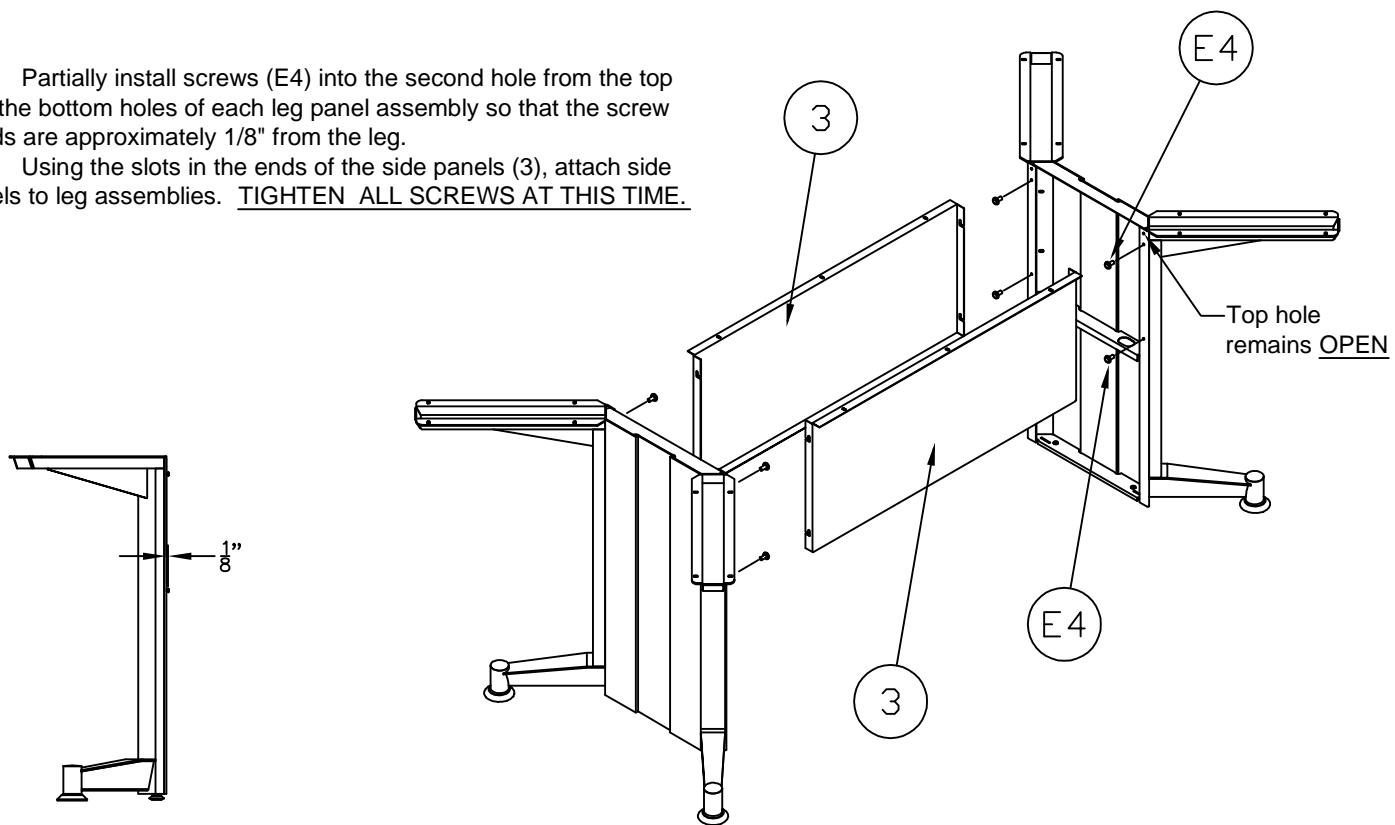

(2)

7. Install slam latch (E6) into inner leg panel cutout (5) as shown.
8. Insert inner leg panel (5) into assembled leg panel slots. Rotate inner leg panel till slam latch catches.

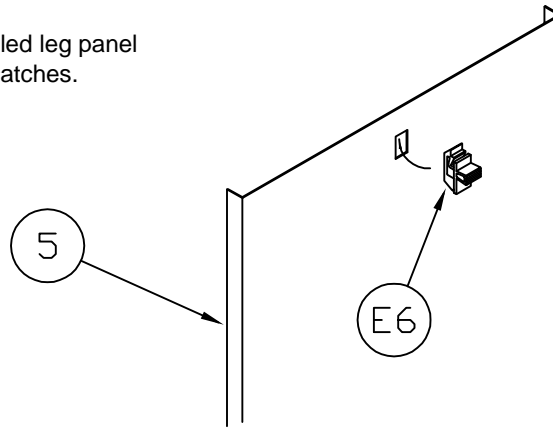

9. Position worksurface (4) on base assembly and fasten using screws (E5) through legs and side panels.

