

**realoffice**

**MAYLINE**

Aberdeen Series™  
Freestanding Lateral File 30"  
Model No. AFLF30

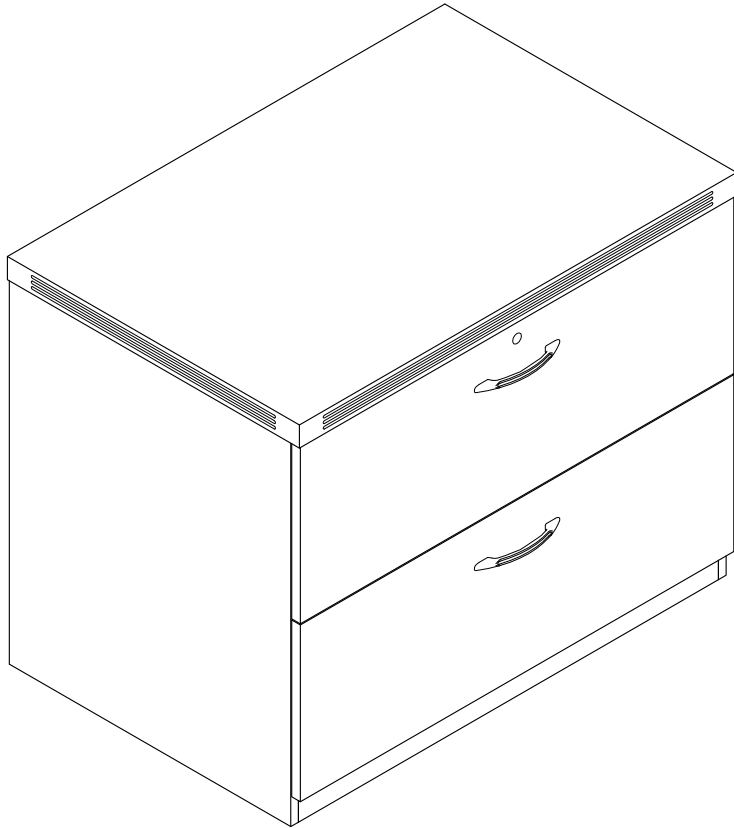

**ASSEMBLY INSTRUCTIONS**  
**CALL 1-800-822-8037 FOR ASSISTANCE**

P/N **AFLF30** REV 06 07/17/14

# PARTS LIST

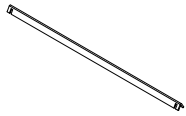
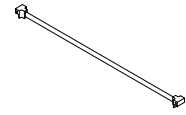
Name	Part	Qty.	Spare Qty
<b>A</b>	 <b>REALS139</b> File Hanging Bar	<b>2</b>	
<b>B</b>	 <b>REALS208</b> 1 Bar w/ 2 Caps	<b>4</b>	

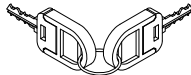
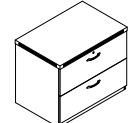
Name	Part	Qty.	Spare Qty
<b>C</b>	 Key	<b>1</b>	
<b>D</b>	 <b>AFLF30**</b> Lateral File	<b>1</b>	

\*\*Denotes Color Code

1

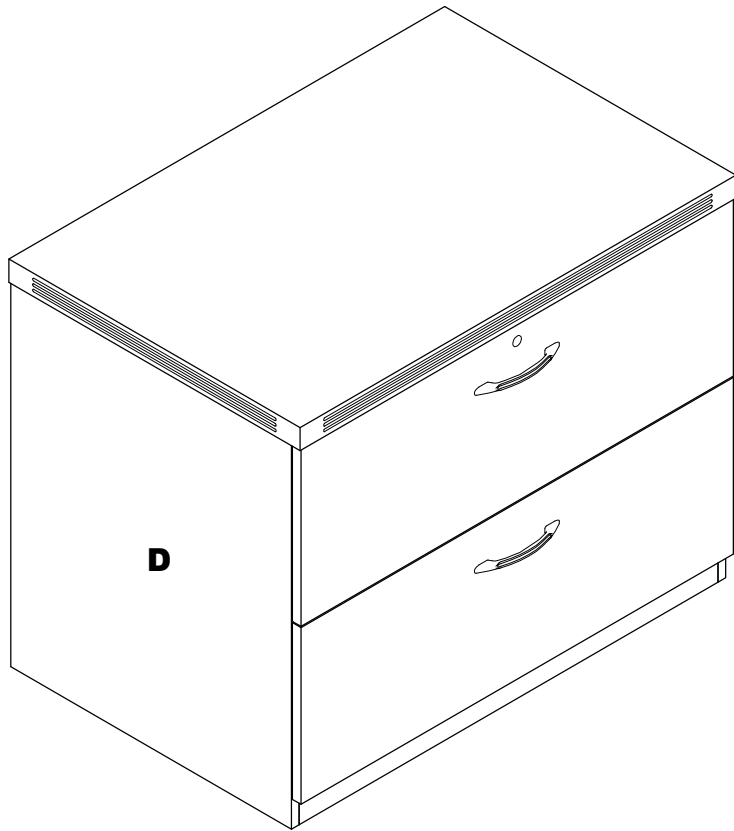

2

2

Arrange File Hangers (B or C) for filing preference.

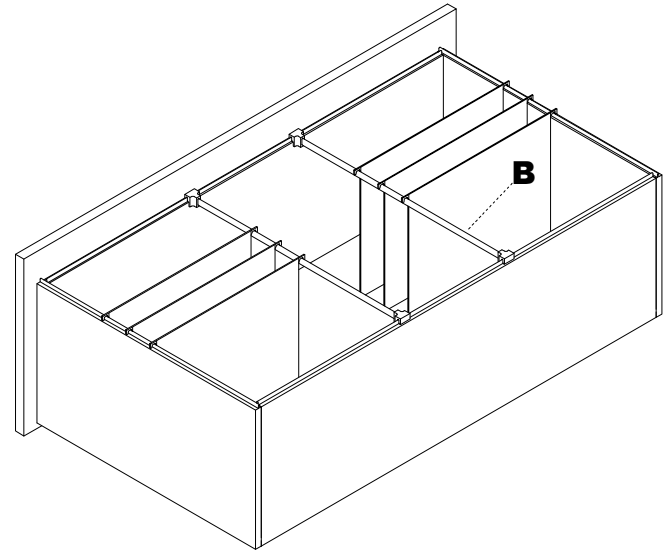

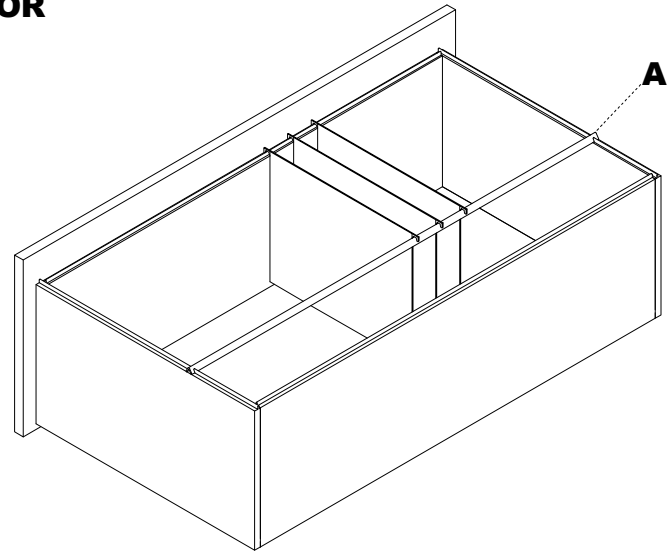

OR

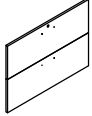
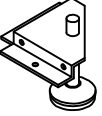
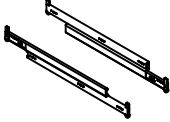
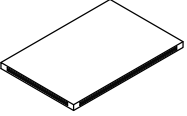

3

# Pre-Installed Replacement Parts List

Part	Included Qty.	Part	Included Qty.
 <b>REALS191</b> Handle w/ 2 Screws	<b>2</b>	 <b>ALF30**</b> Drawer Fronts - Set of 2	<b>1*</b>
 <b>REALS008</b> Corner Bracket w/ Glide	<b>4</b>	 <b>REALS0246<sup>A</sup></b> Drawer Slide 20" - Pair	<b>2</b>
 <b>AFLF30TOP**</b> Top	<b>1*</b>	 <b>REALS005</b> Ø4 x 16mm Corner Bracket Screws	<b>24</b>
 <b>REALS121</b> Ø3 x 14mm Drawer Slide Screws	<b>32</b>	* Available in Cherry (LCR) or Mocha (LDC) finish only. **Denotes Color Code	

<sup>A</sup> Previous drawer slide was REALS055. Change effective 1/19/08.