

realoffice

MAYLINE

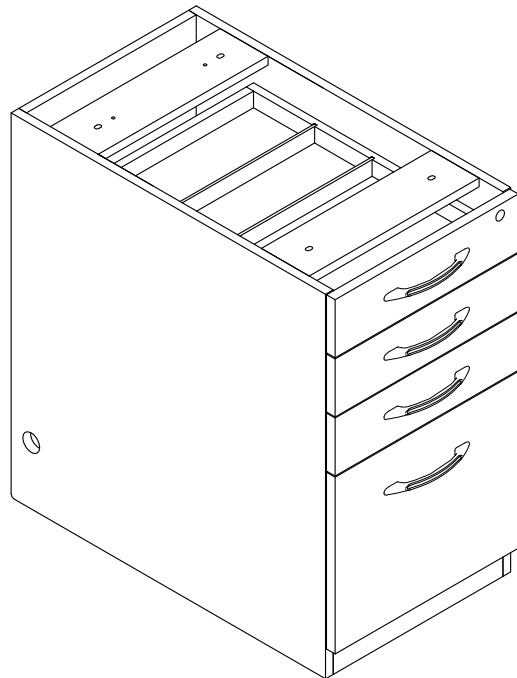

Aberdeen Series™
 Credenza Pencil/Box/Box/File Pedestal
 Model No. APBBF26



ASSEMBLY INSTRUCTIONS
CALL 1-800-822-8037 FOR ASSISTANCE

P/N **APBBF26** REV 07 07/15/10

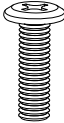
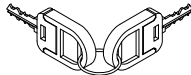
PARTS LIST

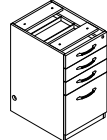
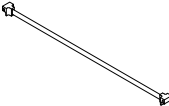
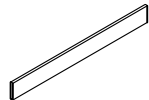
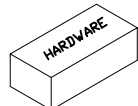
Name	Part	Qty.	Spare Qty	Name	Part	Qty.	Spare Qty
A	 REALS124 M6 x 35mm HB	4	1	D	 Keys HB	1	
B	 REALS104 Grommet HB	1		E	 APBBF26** Pedestal	1	
C	 REALS060 1 Bar w/2 Caps	1		F	 APDD** Pencil Drawer Divider	3	
	 APEDHB						

Items with HB are in hardware box.
 **Denotes Color Code

1

Attach Pedestal (E) to underside of Table using Screws (A).

- OR -



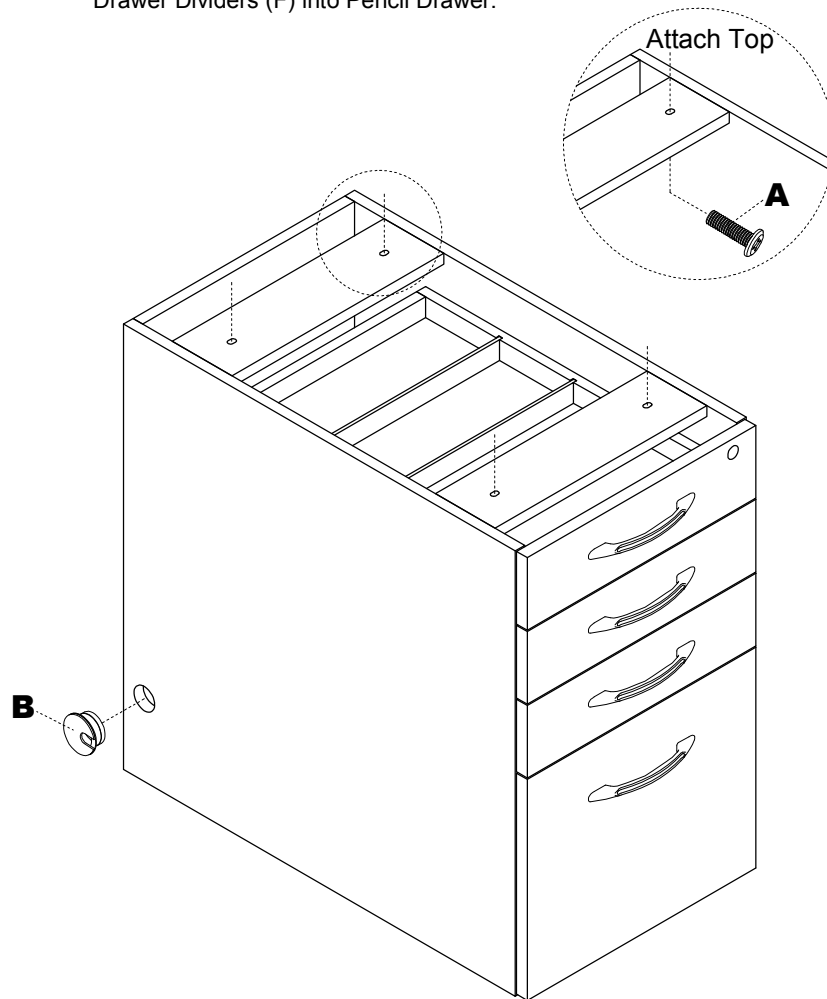

Slide Pedestal (E) under worksurface and adjust levelers as appropriate.

Insert Grommet (B) in exposed side of Pedestal (E) and install Pencil Drawer Dividers (F) into Pencil Drawer.

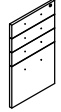

2

Pre-Installed Replacement Parts List

Part	Included Qty.	Part	Included Qty.
 REALS191 Handle w/ Screws	4	 APBBFDF** Drawer Fronts - Set of 4	1*
 REALS008 Corner Bracket w/ Glide	4	 REALS309 A Drawer Slide 22" - Pair	4
 REALS005 Ø4 x 16mm Corner Bracket Screws	24	 REALS121 Ø3 x 14mm Drawer Slide Screws	64

* Available in Cherry (LCR) or Mocha (LDC) finish only.

**Denotes Color Code

A Previous Drawer Slide Was REALS057. Change effective July 10, 2010

3