

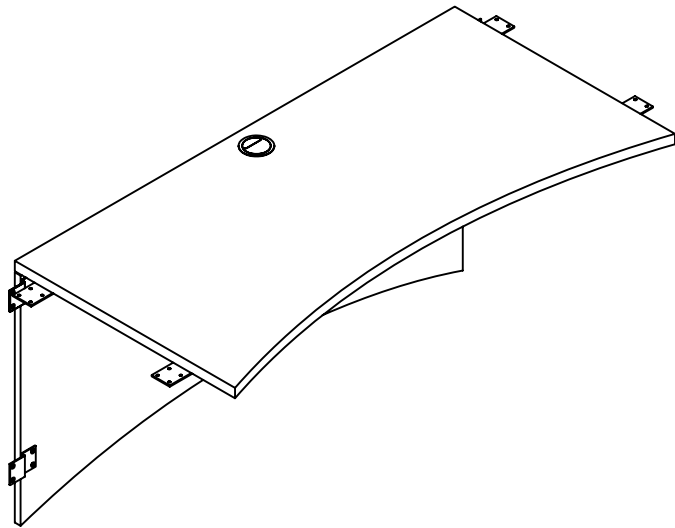







Brighton Series™
Curved Bridge

Model No. BTB4824, BTB4224, BTB3624



ASSEMBLY INSTRUCTIONS
CALL 1-800-822-8037 FOR ASSISTANCE

PARTS LIST

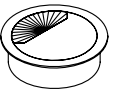
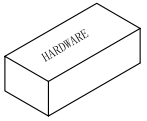
| Name | Part | Qty. | Spare Qty | Name | Part | Qty. | Spare Qty |
|----------|--|----------|-----------|----------|--|-----------|-----------|
| A |  REALS004 Wood Dowel | 2 | 1 | F |  REALBY009 M3.5 x 14mm Black | 16 | 1 |
| B |  REALS001 Cam Lock | 3 | 1 | G |  REALBY011 M4 x 20mm Black | 32 | 1 |
| C |  REALS003 Cam Post | 3 | 1 | H |  REALBY022 Z Bracket | 4 | |
| D |  REALBY005** Cam Sticker | 3 | 1 | J |  REALBY023 Plate (120 x 50 x 3mm) | 4 | |
| E |  REALBY015 Grommet 60mm | 1 | | |  BTB24 | | |

Items with HB are in hardware box.
**Denotes Color Code

PARTS LIST

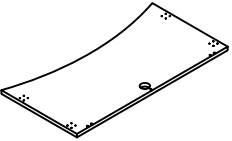
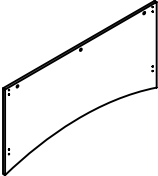
| Name | Part | Qty. | Name | Part | Qty. |
|----------|--|----------|----------|--|----------|
| K |  BTB~~24 K Top | 1 | L |  BTB~~24 L Modesty Panel | 1 |

**Denotes Color Code
~~Denotes Size (48", 42", or 36")

2

- 1** Attach the Modesty Panel (L) to the adjacent Desks or Credenzas using Z Bracket (H) and Screws (F).

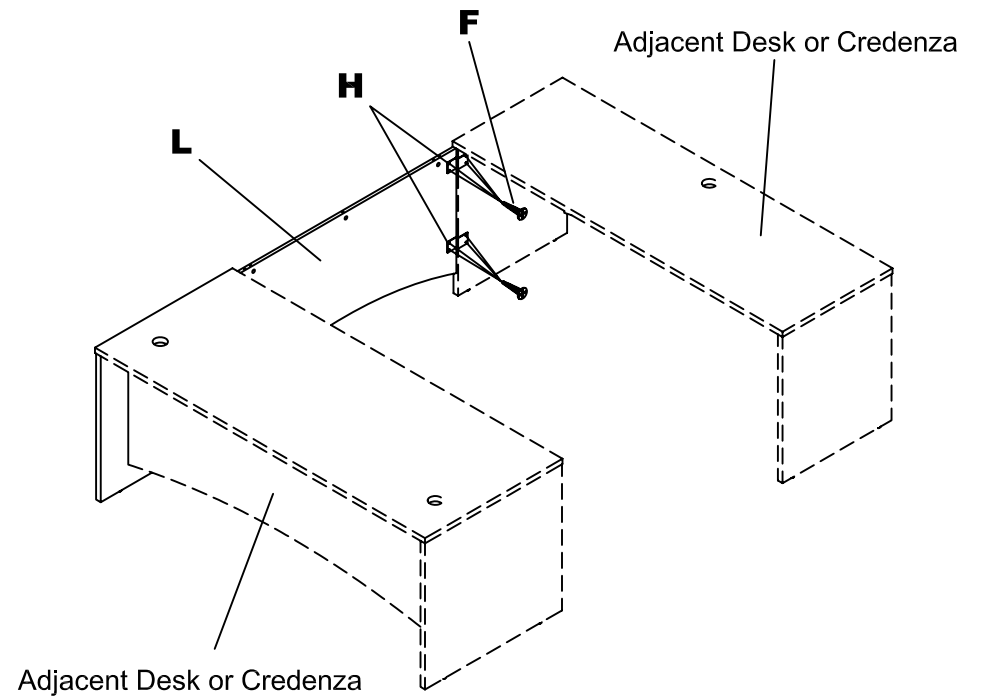

3

- ② Attach Plates (J) to the underside of adjacent Tops using Screws (G).

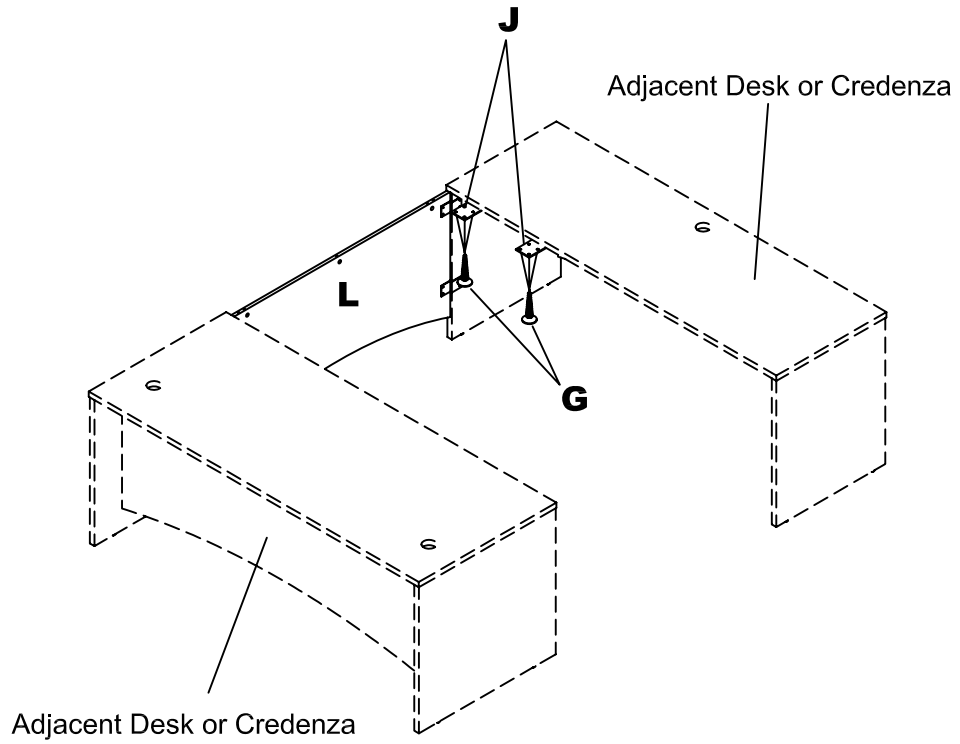

4

- ③ Install Cam Posts (C) into underside of Top (K).

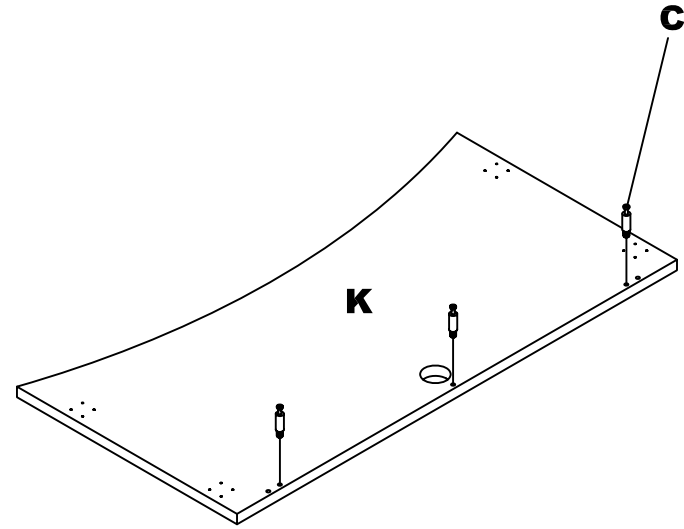

5

- ④ Insert Cams (B) and Dowels (A) into holes in Modesty Panel (L). Secure the Modesty Panel (L) to the Top (K) by turning the Cams (B). Fasten Top (K) to adjacent tops using Plates (J) and Screws (G). Apply Cam Stickers (D) to Cams (B).

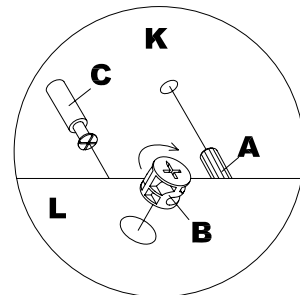
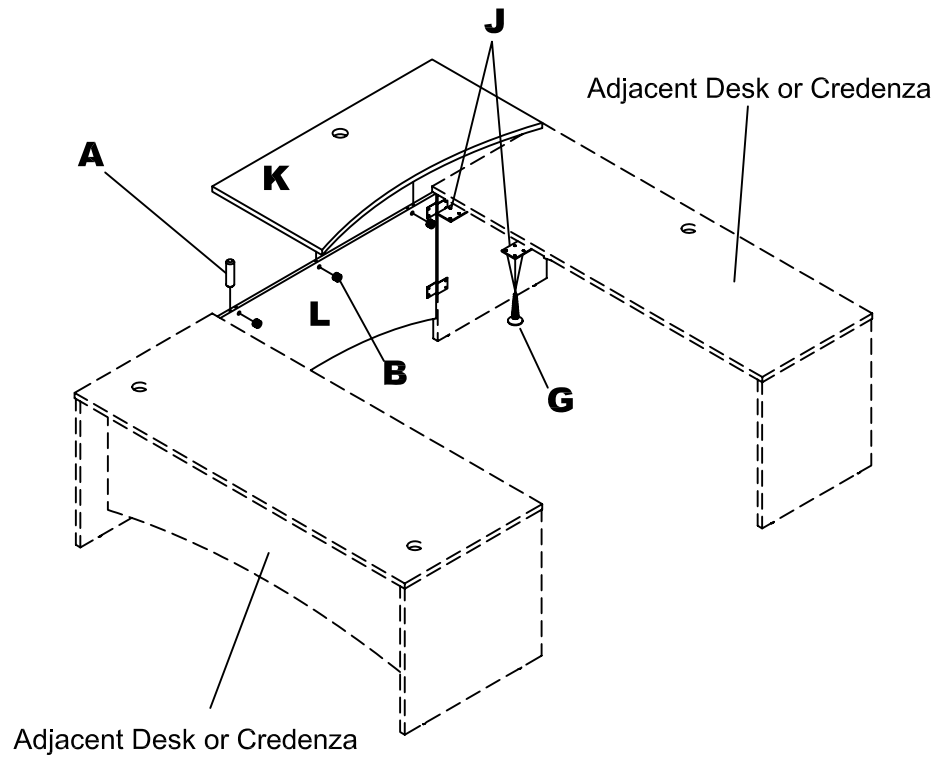

NOTE: The arrow on the face of the Cam (B) should point towards the Cam Post (C) for proper alignment.

6

- ⑤ Insert Grommet (E) into Top (K).

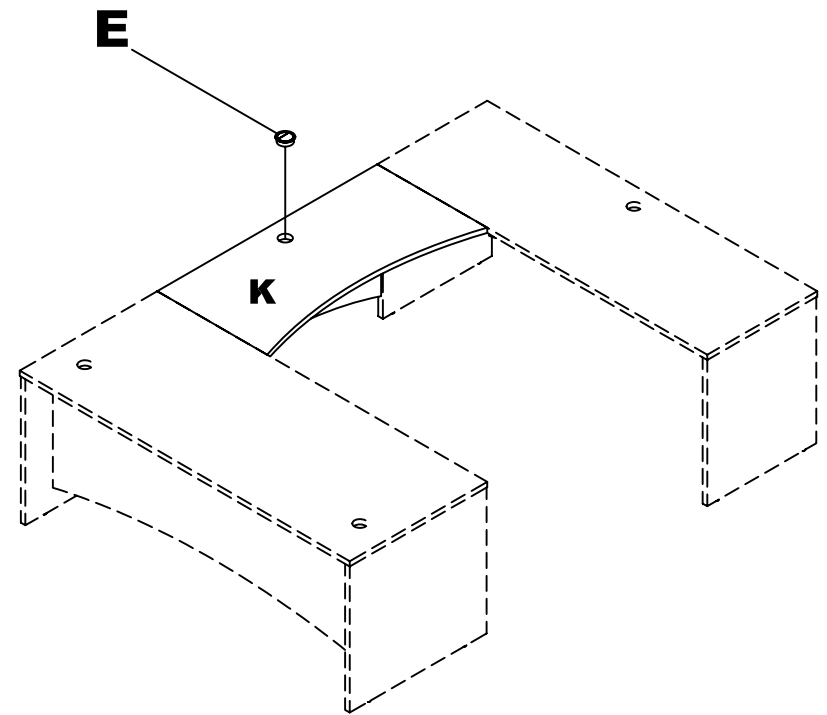

7