

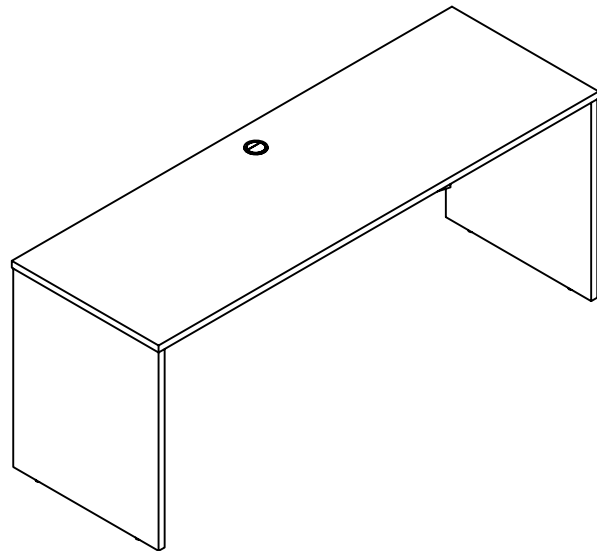



Brighton Series™
Credenza Shell

Model No. BTCD7224, BTCD6624, BTCD6024

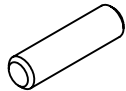
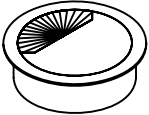
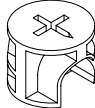
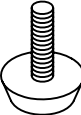

ASSEMBLY INSTRUCTIONS
CALL 1-800-822-8037 FOR ASSISTANCE



PARTS LIST

Name	Part	Qty.	Spare Qty	Name	Part	Qty.	Spare Qty
A	 REALBY004 Wood Dowel	8	1	E	 REALBY015 Grommet 60mm	1	
B	 REALS001 Cam Lock	12	1	F	 REALBY017 Leveler	4	
C	 REALS003 Cam Post	12	1		 BTDHB		
D	 REALBY005** Cam Sticker	12	1				

Items with HB are in hardware box.

**Denotes Color Code

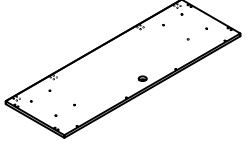
PARTS LIST

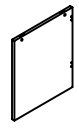
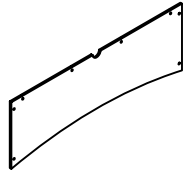
Name	Part	Qty.	Name	Part	Qty.
K	 BTCD~~24K** Top	1	M	 BTCD24M** Right Side Panel	1
L	 BTCD24L** Left Side Panel	1	N	 BTCD~~N** Modesty Panel	1

**Denotes Color Code
~~Indicates (72, 66 or 60)

2

- 1** Insert Wood Dowels (A) into Modesty Panel (N) and the top of the Side Panels (L & M). Insert Cams (B) into the Modesty Panel (N) and Side panels (L & M). Install Cam Posts (C) into threaded inserts in Side Panels (L & M). Install Levelers (F) into bottom of Side Panels (L & M). Attach Modesty Panel (N) to Side Panels (L & M) by turning Cams (B).

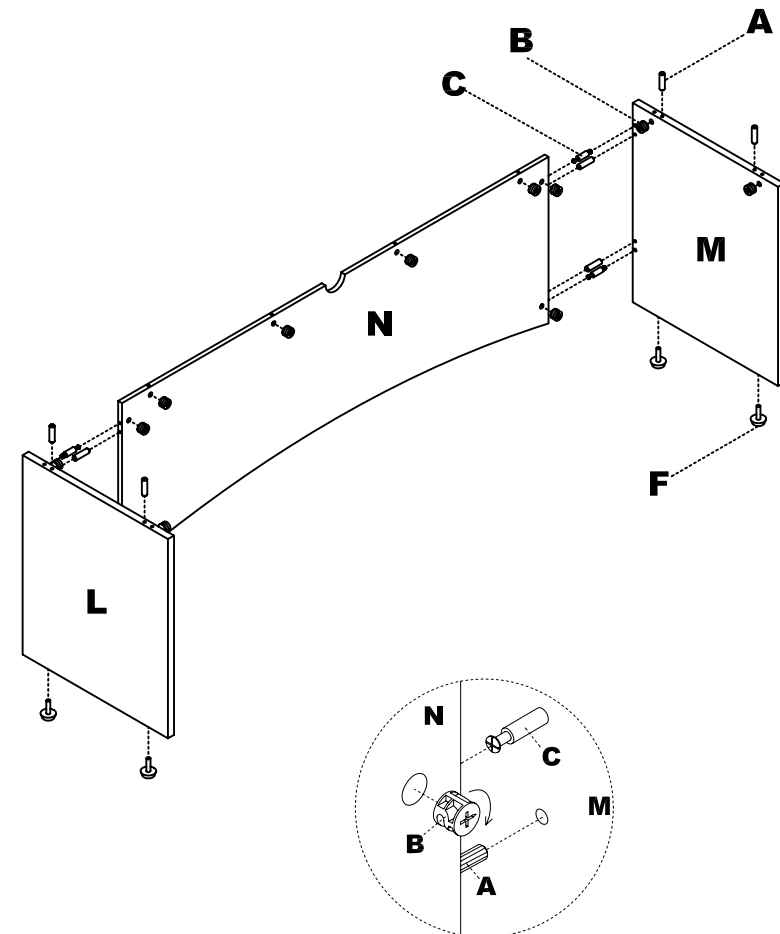

NOTE: The arrow on the face of the Cam (B) should point towards the Cam Post (C) for proper alignment.

3

- ② Install Cam Posts (C) into threaded inserts in underside of Top (K).

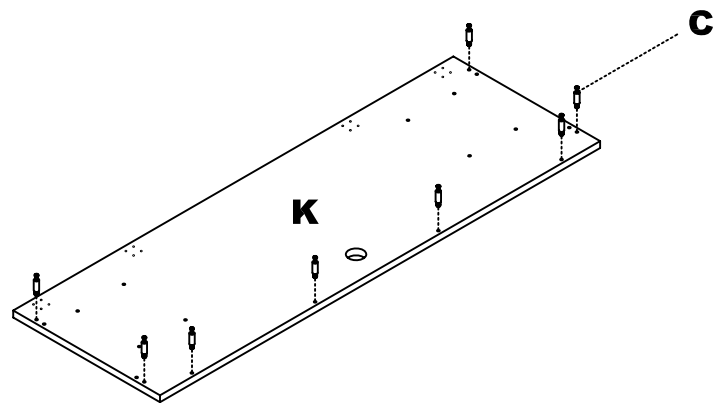

4

- ③ Place Top (K) onto base and lock in place by turning Cams (B). Apply Cam Stickers (D) onto Cams (B) and insert Grommet (E) into Top (K).

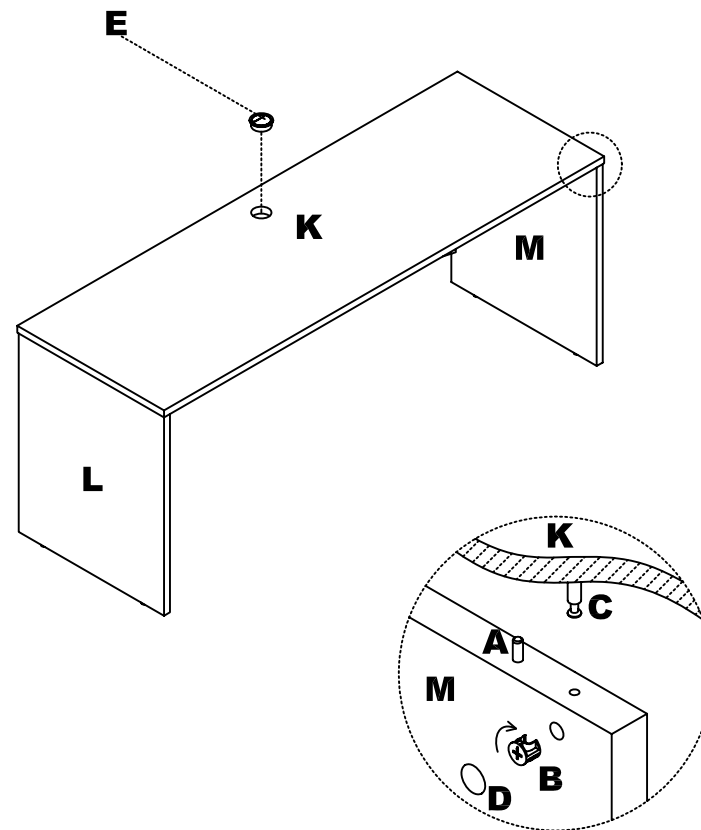

5