

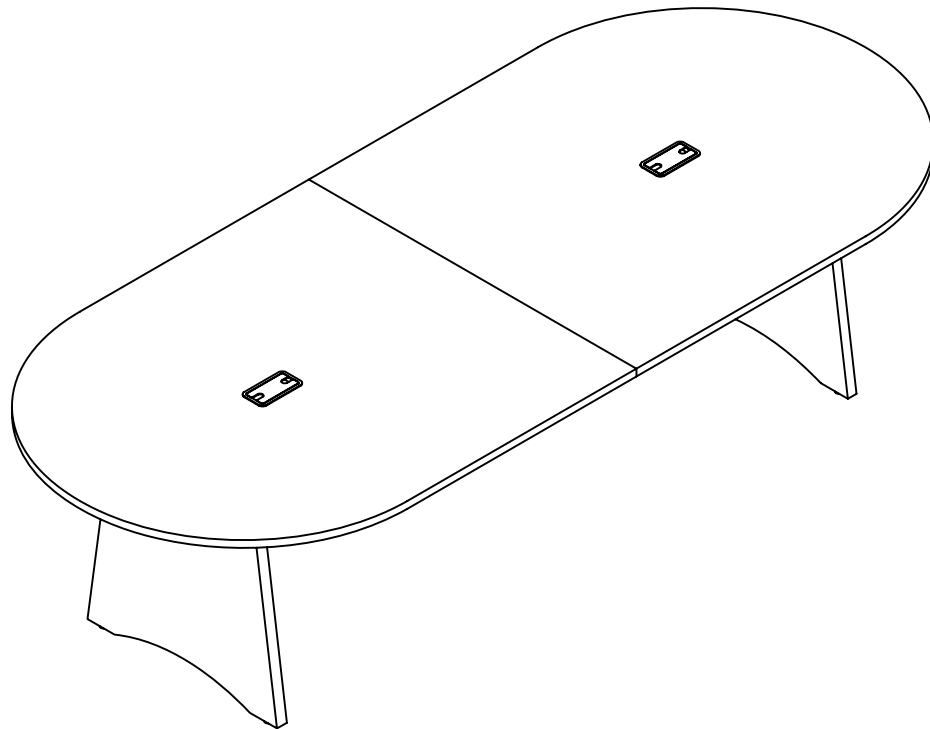

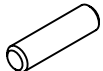





Brighton Series™  
10' Racetrack Conference Table  
Model No. BTCT10

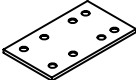

**ASSEMBLY INSTRUCTIONS**  
**CALL 1-800-822-8037 FOR ASSISTANCE**

# PARTS LIST

Name	Part	Qty.	Spare Qty	Name	Part	Qty.	Spare Qty
<b>A</b>	 <b>REALS004</b> Wood Dowel	<b>6</b>	<b>1</b>	<b>F</b>	 <b>REALBY017</b> Leveler	<b>2</b>	
<b>B</b>	 <b>REALS001</b> Cam	<b>10</b>	<b>1</b>	<b>H</b>	 <b>REALBY050</b> Joining Plate 100 x 60	<b>1</b>	
<b>C</b>	 <b>REALS003</b> Cam Post	<b>10</b>	<b>1</b>	<b>J</b>	 <b>REALBY009</b> M3.5 x 14mm Black	<b>9</b>	<b>1</b>
<b>D</b>	 <b>REALS102**</b> Cam Sticker	<b>10</b>	<b>1</b>		 <b>BTCT10HB</b> (2 Required)	<b>1</b>	
<b>E</b>	 <b>REALBY046</b> Grommet, Black	<b>1</b>					

NOTE: Each BTCT10T carton will contain (1) BTCT10HB Hardware Box.

Items with HB are in hardware box.  
\*\*Denotes Color Code

# PARTS LIST

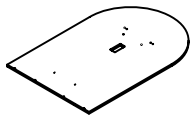
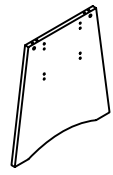
Name	Part	Qty.
<b>K</b>	 <b>BTCT10K**</b> Top	<b>1</b>
<b>L</b>	 <b>BTCT8L**</b> Leg	<b>1</b>

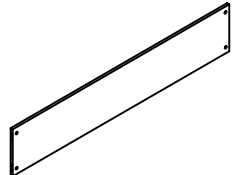
Name	Part	Qty.
<b>M</b>	 <b>BTCT10M**</b> Modesty Panel	<b>2</b>

\*\*Denotes Color Code

**2**

- 1 Insert Wood Dowels (A) into Modesty Panels (M) and the top of the Legs (L). Insert Cams (B) into the Modesty Panels (M) and Legs (L). Install Cam Posts (C) into threaded inserts in Legs (L). Install Levelers (F) into bottom of Legs (L). Attach Modesty Panels (M) to Legs (L) by turning Cams (B).

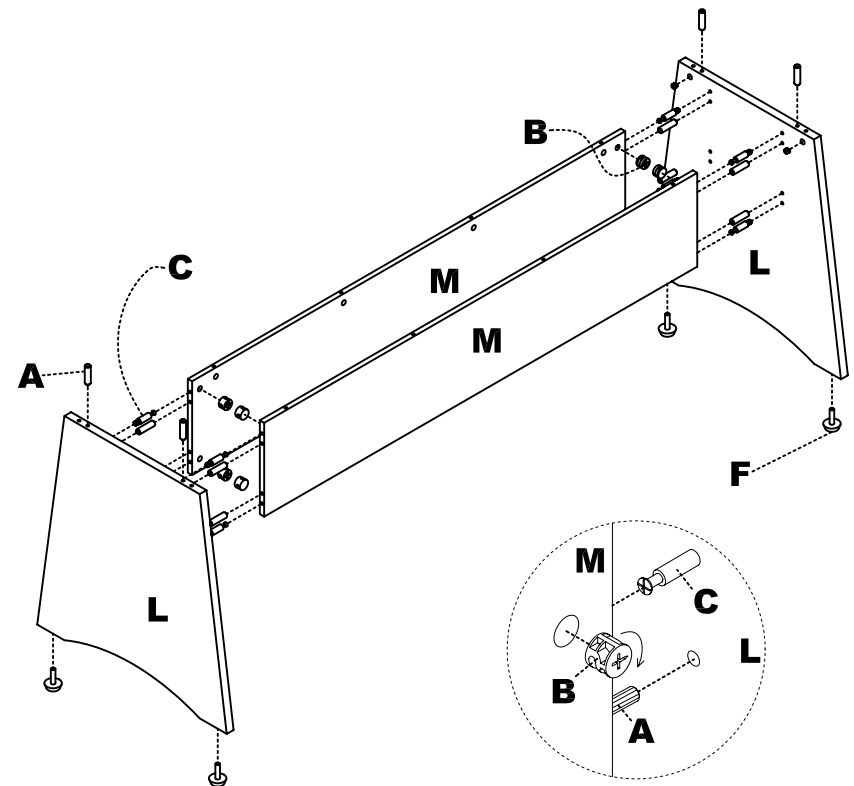

NOTE: The arrow on the face of the Cam (B) should point towards the Cam Post (C) for proper alignment.

**3**

- 2 Install Cam Posts (C) into the underside of the Top (K).

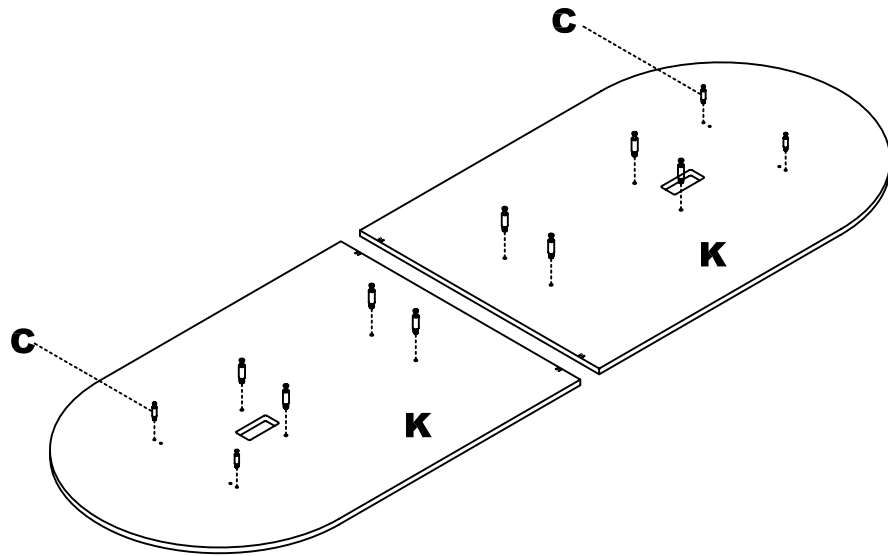

4

- 3 Place Top (K) onto the Leg Assembly. Tighten Top (K) to Leg Assembly by turning Cams (B). Install Joining Plate (H) at Top (K) seams using Screws (J). Adhere Stickers (D) onto exposed Cams (B). Insert Grommets (E) into Top holes.

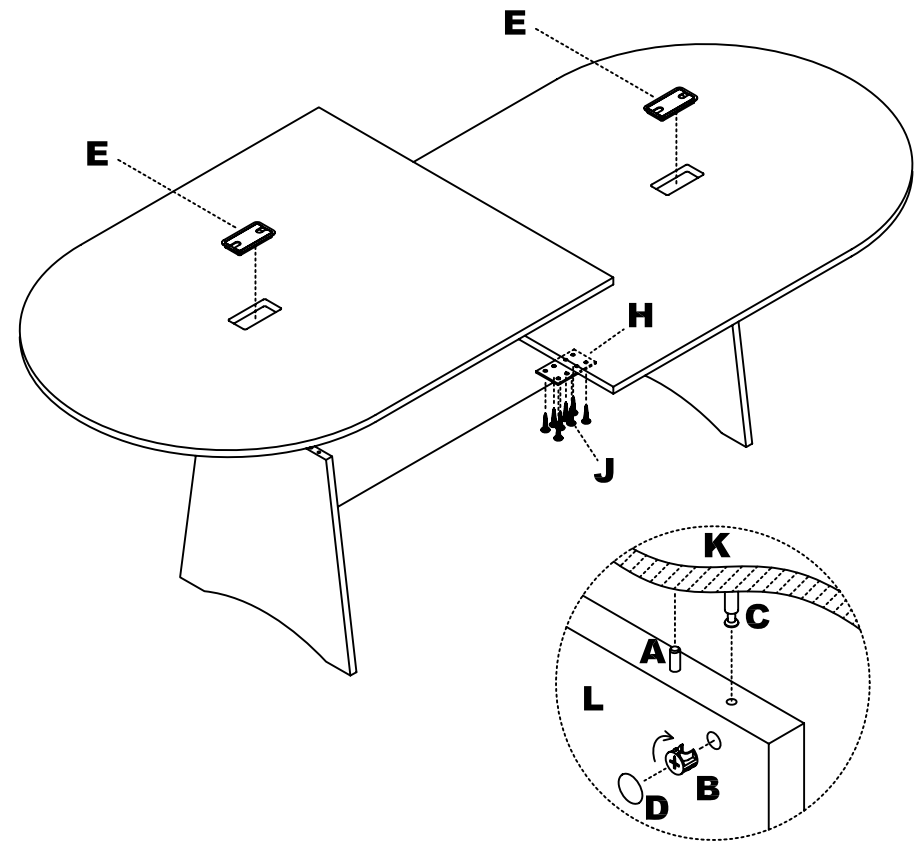

5