

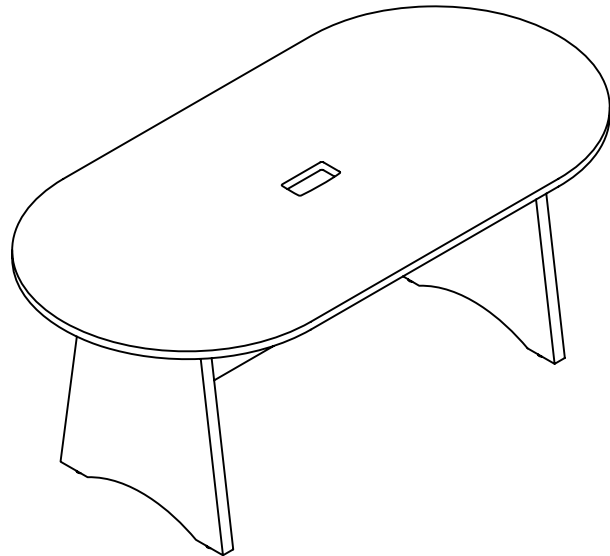

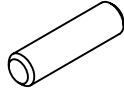

Brighton Series™
6' Racetrack Conference Table
Model No. BTCT6

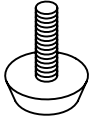
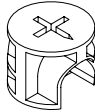

ASSEMBLY INSTRUCTIONS
CALL 1-800-822-8037 FOR ASSISTANCE

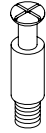

PARTS LIST

Name	Part	Qty.	Spare Qty	Name	Part	Qty.	Spare Qty
A	 REALS004 Wood Dowel	12	1	E	 REALBY017 Leveler	4	
B	 REALS001 Cam Lock	18	1	F	 REALBY046 Grommet	1	
C	 REALS002 Cam Post	18	1		 BTCT8HB		
D	 REALBY005** Cam Sticker	18	1				

Items with HB are in hardware box.

**Denotes Color Code

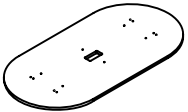
PARTS LIST

Name	Part	Qty.
K	 BTCT6K** Top	1
L	 BTCT6L** Leg	2

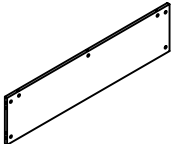
Name	Part	Qty.
M	 BTCT6M** Modesty Panel	2

**Denotes Color Code

2

- ① Insert Wood Dowels (A) into Modesty Panels (M) and the top of the Legs (L). Insert Cams (B) into the Modesty Panels (M) and Legs (L). Install Cam Posts (C) into threaded inserts in Legs (L). Install Levelers (F) into bottom of Legs (L). Attach Modesty Panels (M) to Legs (L) by turning Cams (B).

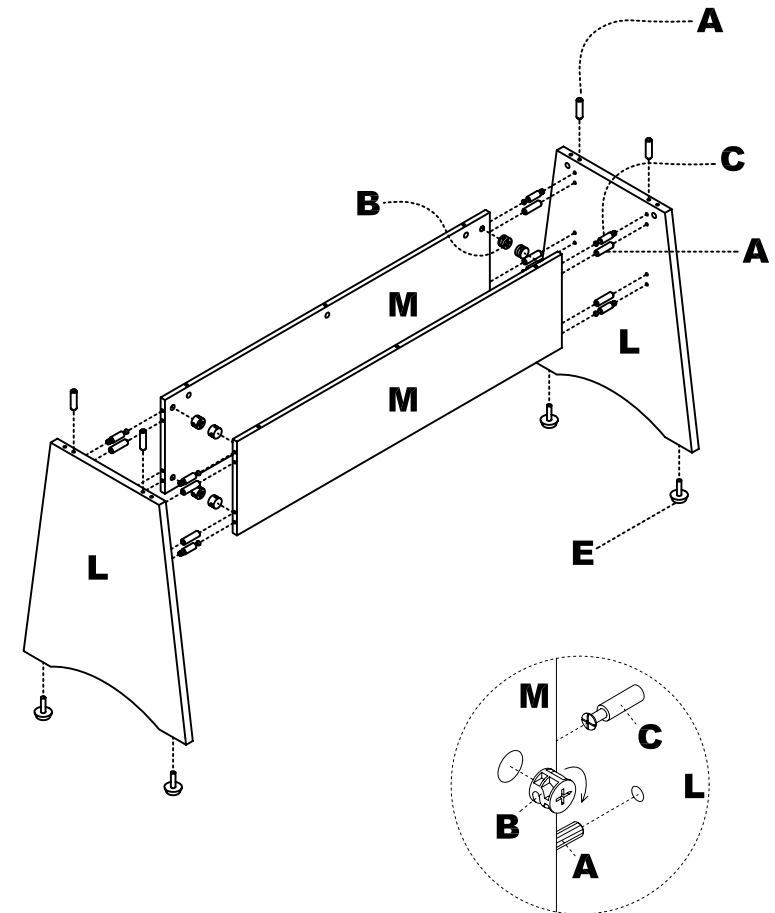

NOTE: The arrow on the face of the Cam (B) should point towards the Cam Post (C) for proper alignment.

3

- ② Install Cam Posts (C) into the underside of the Top (K).

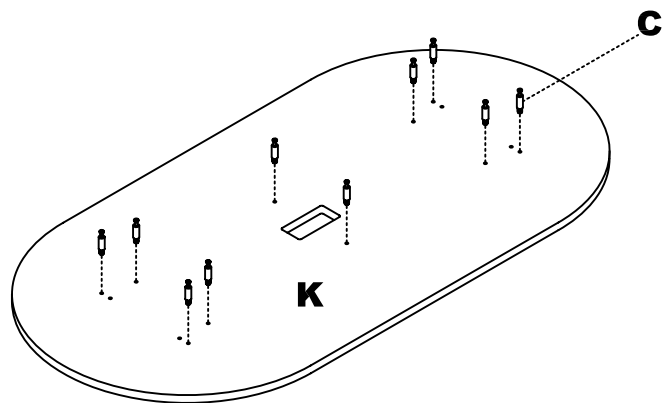

4

- ③ Place the Top (K) onto the Leg Assembly. Tighten Top (K) to Legs (L) and Modesty Panels (M) by turning Cams (B). Adhere Stickers (D) onto exposed Cams (B). Install Grommet (F) into Top.

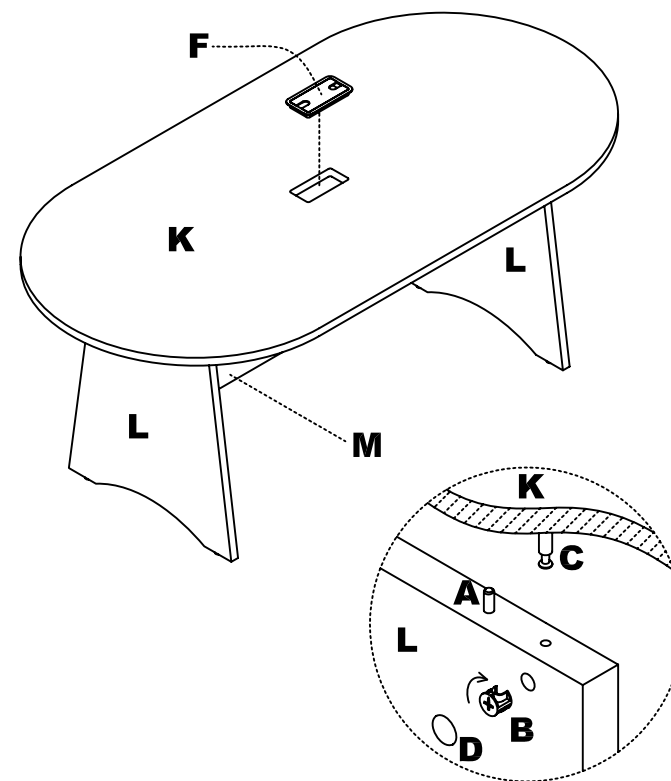

5