

# CS11 36" 4 DRAWER LATERAL FILE

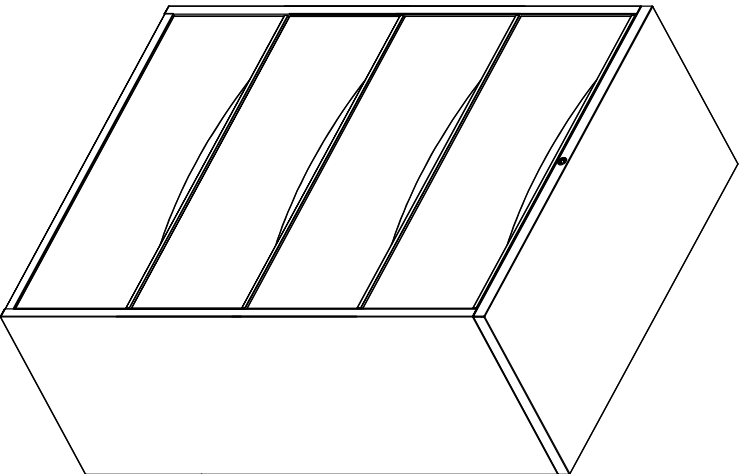





Model No. C844H



## ASSEMBLY INSTRUCTIONS

CALL 1-800-822-8037 FOR ASSISTANCE

## Pre-Installed Replacement Parts List

Part	Included Qty.	Part	Included Qty.
 <b>C84HDS</b> Slide 15.5" (Pair)	4	 <b>C8436FB</b> File Bar, Side-to-Side	4
 <b>C8436DF**</b> Drawer Front, 36"	4	 <b>C88LCKH</b> Lock Assembly	1
 <b>C84FB</b> File Bar, Front-to-Back	8	 <b>C84L</b> Leveler	4

\*\*Denotes Color Code



© Mayline Company, LLC  
 619 N. Commerce, P.O. Box 728  
 Sheboygan, WI 53082-0728  
 Toll Free: 1-800-822-8037  
 FAX: 920-437-7388  
 On Line: www.mayline.com

**Long filing bar used for lateral filing.**

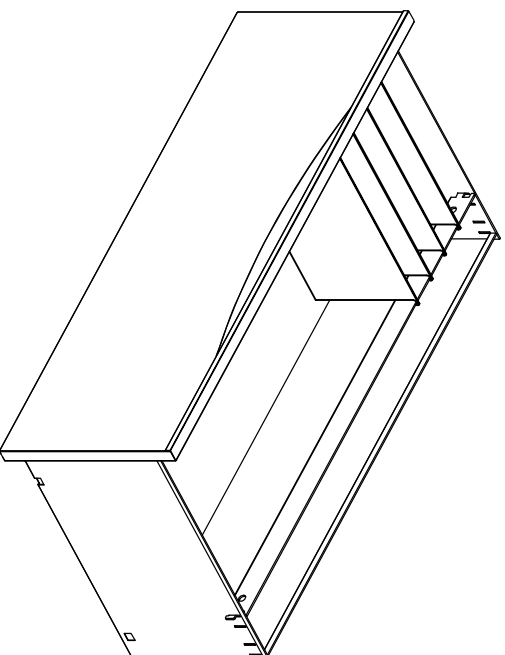

**Short filing bar used for front-to-back filing.**

