

CS11 42" 4 DRAWER LATERAL FILE

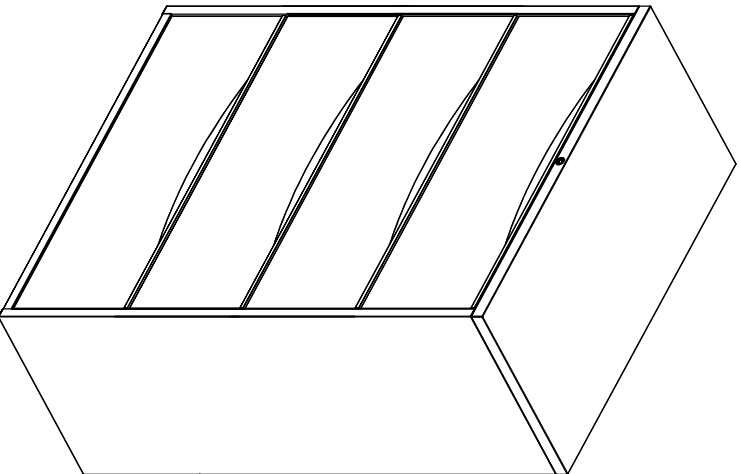





Model No. C845H



ASSEMBLY INSTRUCTIONS

CALL 1-800-822-8037 FOR ASSISTANCE

Pre-Installed Replacement Parts List

Part	Included Qty.	Part	Included Qty.
 C84HDS Slide 15.5" (Pair)	4	 C84422FB File Bar, Side-to-Side	4
 C8442DF** Drawer Front, 42"	4	 C88LCKH Lock Assembly	1
 C84FB File Bar, Front-to-Back	8	 C84L Leveler	4

**Denotes Color Code



© Mayline Company, LLC
 619 N. Commerce, P.O. Box 728
 Sheboygan, WI 53082-0728
 Toll Free: 1-800-822-8037
 FAX: 920-437-7388
 On Line: www.mayline.com

Long filing bar used for lateral filing.

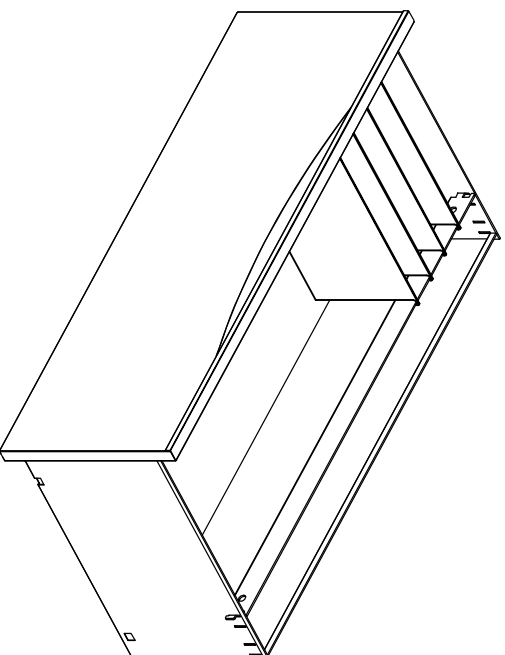

Short filing bar used for front-to-back filing.

