

CS11 36" 5 DRAWER LATERAL FILE

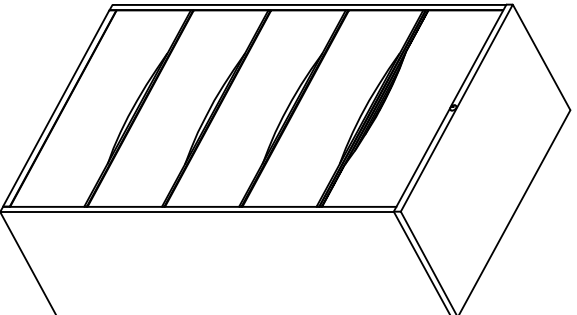





Model No. C846H



ASSEMBLY INSTRUCTIONS

CALL 1-800-822-8037 FOR ASSISTANCE

Pre-Installed Replacement Parts List

Part	Included Qty.	Part	Included Qty.
 C84HDS Slide 15.5" (Pair)	5	 C8436FB File Bar, Side-to-Side	5
 C8436DF** Drawer Front, 36"	4	 C88LCKH Lock Assembly	1
 C84FB File Bar, Front-to-Back	10	 C84L Leveler	4
 C8436TDF** Top Drawer Front, 36"	1		

**Denotes Color Code

P/N **C846H** Rev. 02 08/10



© Mayline Company, LLC
 619 N. Commerce, P.O. Box 728
 Sheboygan, WI 53082-0728
 Toll Free: 1-800-822-8037
 Fax: 920-437-7388
 On Line: www.mayline.com

Long filing bar used for lateral filing.

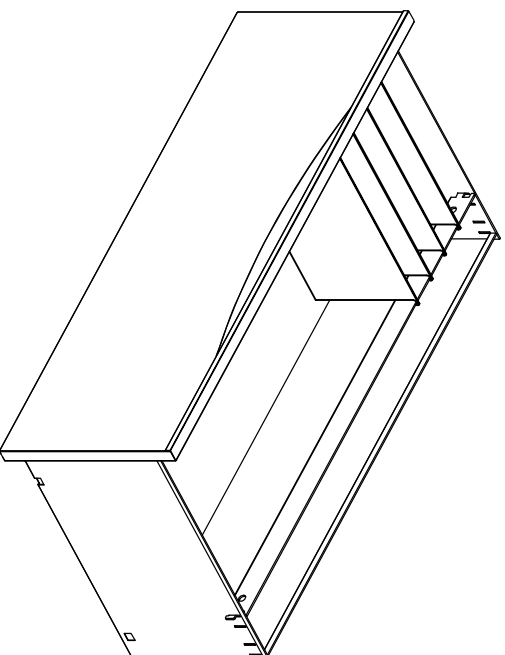

Short filing bar used for front-to-back filing.

