

CS11 17.5" FILE/FILE PEDESTAL

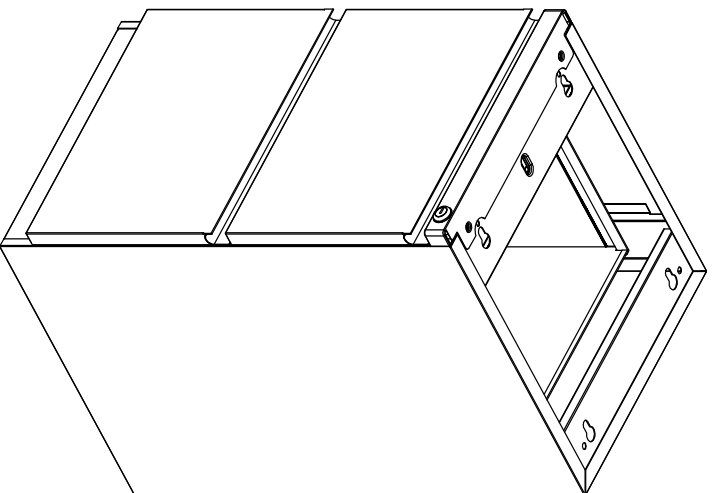

Model No. C8817F





ASSEMBLY INSTRUCTIONS

CALL 1-800-822-8037 FOR ASSISTANCE

Hardware Bag

Part	Included Qty.	Part	Included Qty.
 Keys	1	 700287 File Hanging Bar w/ Clips	2
 C88GBK Leveler	4		

Pre-Installed Replacement Parts List

Part	Included Qty.	Part	Included Qty.
 C8817SH Slide 14" (Pair)	2	 C88LCKH Lock Assembly	1
 C88FDH** Drawer Front, File	2		

**Denotes Color Code



P/N C8817F 10/09

© Mayline Company, LLC
619 N. Commerce, P.O. Box 728
Sheboygan, WI 53082-0728
Toll Free: 1-800-822-8037
Fax: 920-437-7388
On Line: www.mayline.com