

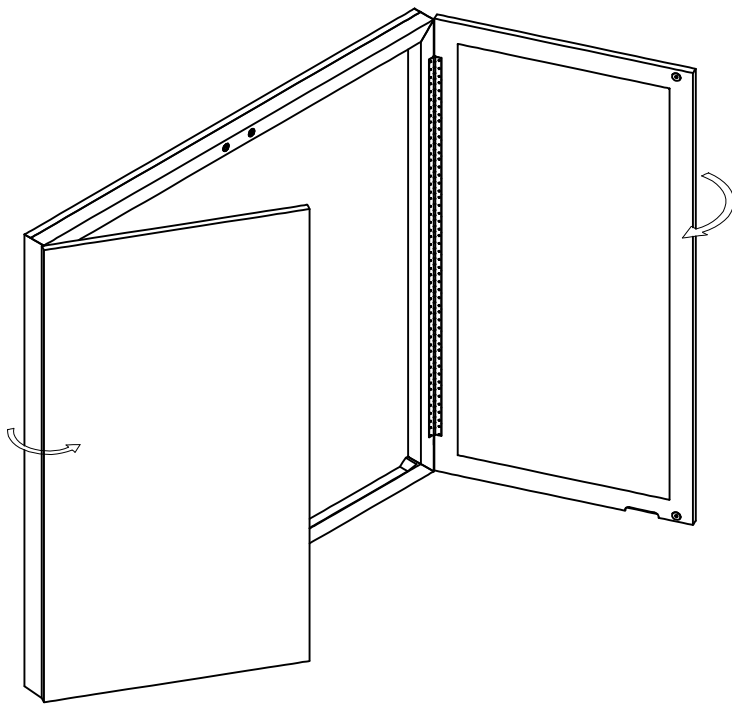



Corsica Series
Presentation Board
Model No. CTMB

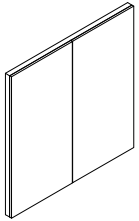
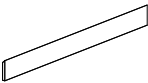
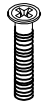
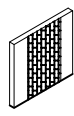
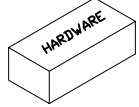

ASSEMBLY INSTRUCTIONS
CALL 1-800-822-8037 FOR ASSISTANCE

PARTS LIST

Name	Part	Qty.	Name	Part	Qty.
A	 HB REALS125 4 x 45mm	1	E	 CTMB** Presentation Board	1
B	 CTMBB Mounting Bracket	1	F	 HB REALS071 M6 x 20mm	2
C	 HB REALS092 Foam Spacer	6		 HB CTMBHB	
D	 HB REALS093 Mounting Bracket	1			

Items with HB are in hardware box.
**Denotes Color Code

IMPORTANT!

Review **ALL** instructions before beginning assembly . These instructions are provided to avoid problems that may occur from improper assembly or installation. Mayline and/or its distributor are not responsible for failure resulting from improper assembly or installation of this product. Moreover, all warranties are void for failure to follow these assembly instructions.

- 1** Mounting Board Installation - Due to the various wall construction methods, it is up to a professional installer to secure the Mounting Bracket (B) to the wall with the proper fasteners and/or anchors as required by the wall construction at the desired mounting location. Mayline does not take responsibility for safe, proper fastening.

To Hang Presentation Board - Position Presentation Board so that the pre-attached wall mounting bracket (See Below) is centered and above Mounting Bracket (B) and lower Presentation Board until wall mounting bracket and Mounting Bracket (B) lock together. (See Step 2)

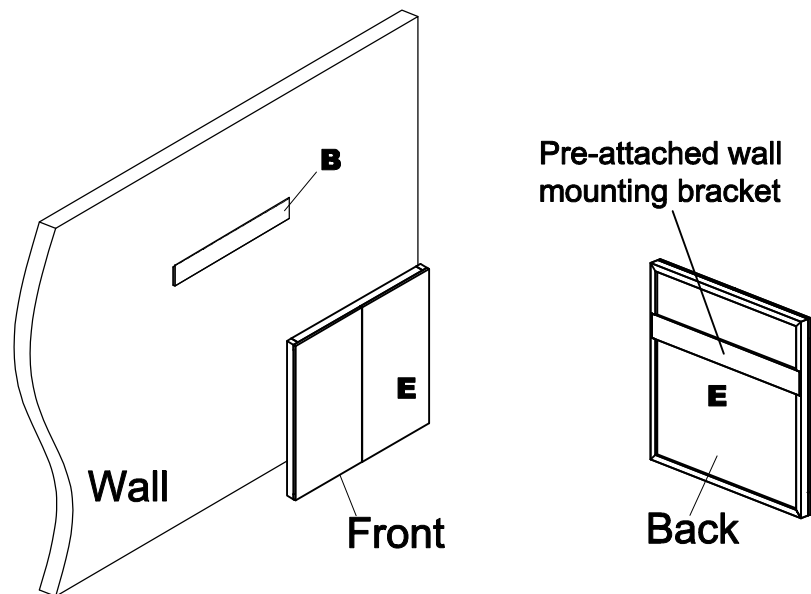

2

2

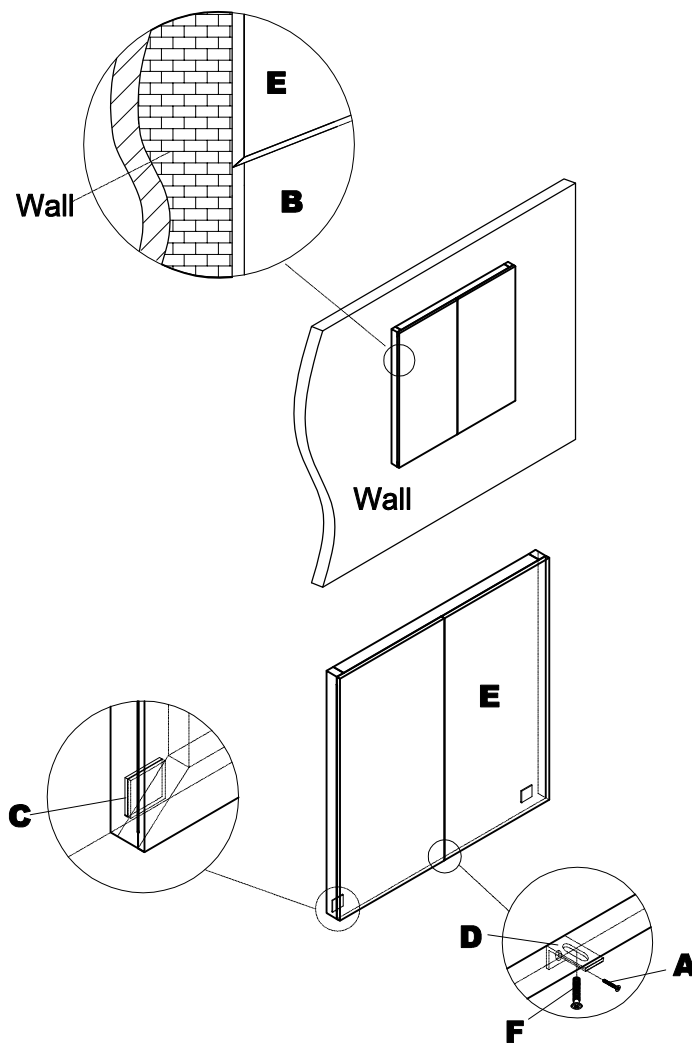

Place foam spacer (part C) at white line on the backside of the presentation board prior to attaching bracket (part D) Attach the bracket to the bottom of the presentation board using screw (part F) then attach the bracket to the wall using screw (part A)

3

Pre-Assembled Replacement Part List

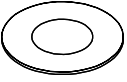
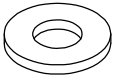
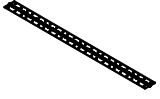
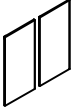
Replacement #	Part	Qty.
REALS096		4
REALS255		4
REALS512	 Hinge-Piano	2
CTMBDR**	 Doors - Pair	1

**Denotes Color Code

Real Office Care Instructions

Finish Color Matching

Different wood species offer unique texture and grain. Minor variations in finish color, density or shade may occur due to natural characteristics of wood. The term "color match" and consistency are often misleading. The best case achievable using a natural product like wood in a wide variety of lighting conditions is a good "blend" of color and tone throughout the project area. The natural color of the wood product is even altered by the application of a "clear" topcoat finish. The apparent consistency of the color is a combination of light reflectance, cellular structure, natural characteristics, applied colors and sheen. - Architectural Woodwork Quality Standards

Illustrated, 7th Edition, Version 1.0, 1997, pg. 454

Proper Care of Wood Surfaces

With proper care of the wood surfaces and finishes, your office furniture will provide elegance and convenience for years. Please reference these easy-to-follow guidelines whenever you have a question.

- Clean all surfaces frequently with a soft cloth dampened with warm water, moving the cloth with the grain. **(Do not use furniture polish, solvents or any wax or oil base products.) Never use paper towel.**
- Immediately remove any liquids that come in contact with wood surfaces with a blotting action.
- Lift objects to move them, never pull them across the finished surface.
- Avoid exposure of furniture to extremes of heat and cold, or to wide humidity variances.
- For an additional safeguard, use a protective desk pad. This single item could ensure a lasting finish by protecting your furniture from possible damage caused by pens and sharp objects.
- Do not leave plastic, vinyl or rubber items on finished wood surfaces. Sustained contact may cause deterioration of the finish due to possible chemical reaction between the plastic, vinyl or rubber and the catalyzed lacquer finish.
- If using a protective glass top, place spacer pads under the glass top to allow the wood to breathe.
- Avoid exposure of furniture to strong sunlight. The wood underneath the finish may change color from prolonged exposure to sunlight.
- Avoid exposure of furniture to harsh solvents (nail polish remover, acetates, etc.), as it will cause finish deterioration.

If you have any additional questions please contact our customer service department at 1-800-822-8037

realoffice

www.mayline.com