

17.5" FILE/FILE PEDESTAL

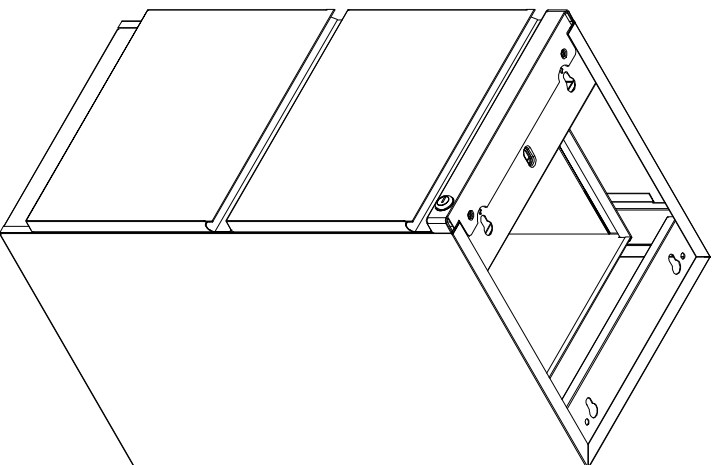



Model No. P172





ASSEMBLY INSTRUCTIONS

CALL 1-800-822-8037 FOR ASSISTANCE

Hardware Bag

Part	Included Qty.	Part	Included Qty.
 Keys	1	 700295 File Hanging Bar w/ Clips	2
 700284H Tail Lever, .90"	4	 700285H Short Lever	4

Pre-Installed Replacement Parts List

Part	Included Qty.	Part	Included Qty.
 P17SH Slide 18" (Pair)	2	 C88LCKH Lock Assembly	1
 C88FDH** Drawer Front, File	2		

**Denotes Color Code

P/N **P172** 3/13



Mayline Company, LLC
 619 N. Commerce, P.O. Box 728
 Sheboygan, WI 53082-0728
 Toll Free: 1-800-822-8037
 FAX: 920-457-7388
 On Line: www.mayline.com