

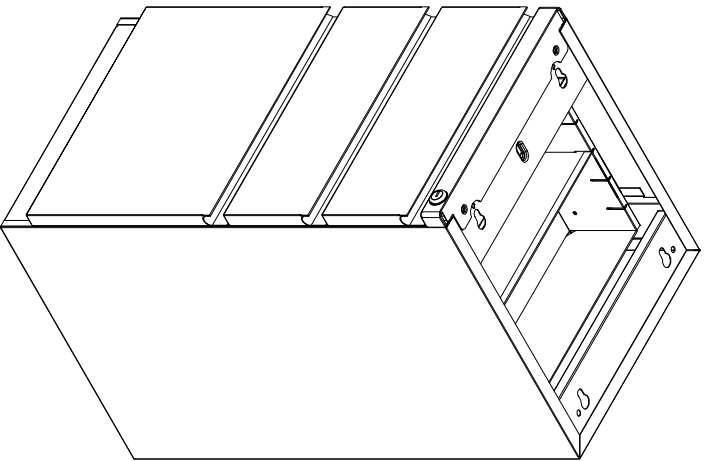





# 17.5" BOX/BOX/FILE PEDESTAL

Model No. P173



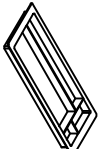



**ASSEMBLY INSTRUCTIONS**  
**CALL 1-800-822-8037 FOR ASSISTANCE**

## Hardware Bag

Part	Included Qty.	Part	Included Qty.
 Keys	1	 <b>700299</b> Pencil Tray 4.88" x 12.88"	1
 <b>700284H</b> Tail Leveler, .90"	4	 <b>700295</b> File Hanging Bar w/ Clips	1
 <b>700285H</b> Short Leveler	4		

## Pre-Installed Replacement Parts List

Part	Included Qty.	Part	Included Qty.
 <b>P17SH</b> Slide 16" (Pair)	3	 <b>C88FDH**</b> Drawer Front, File	1
 <b>C88BDH**</b> Drawer Front, Box	2	 <b>C88LCKH</b> Lock Assembly	1

\*\*Denotes Color Code

P/N **P173** 3/13



Mayline Company, LLC  
 619 N. Commerce, P.O. Box 728  
 Sheboygan, WI 53082-0728  
 Toll Free: 1-800-822-8037  
 FAX: 920-457-7388  
 On Line: www.mayline.com