

**Sorrento Desk FF Pedestal
Model No. SDFF**

(Shown in SCR Finish)

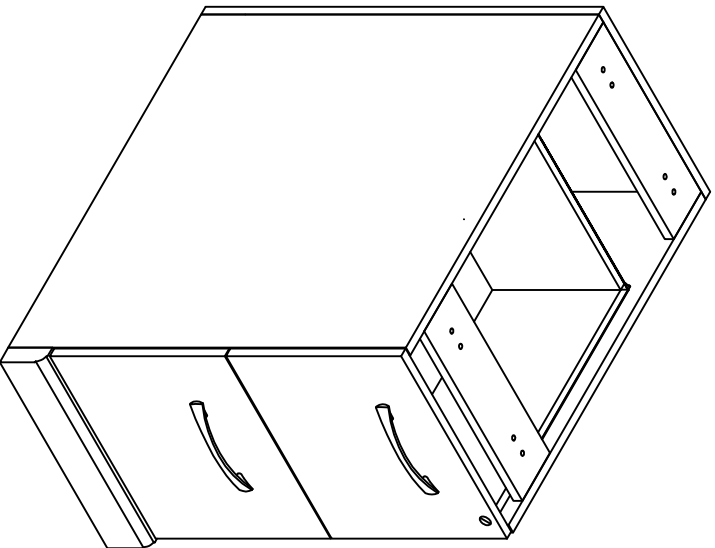





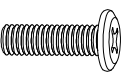
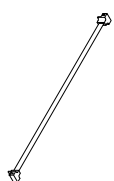

ASSEMBLY INSTRUCTIONS

CALL 1-800-822-8037 FOR ASSISTANCE

P/N **SDFF** REV 04 10/21/08

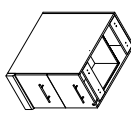
PARTS LIST

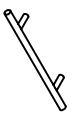
Name	Part	Qty.	Spare Qty.	Name	Part	Qty.	Spare Qty.
A	 REALS240 M6 x 30mm HB	4	1	E	 REALS060 File Hanger HB	2	
B	 REALS249 M4 x33mm HB	4		F	 Keys HB	1	
C	 REALS004 Wood Dowel HB	4	1	G	 SDFF** Pedestal	1	
D (SCR)	 REALS232 Handle HB	2					
D (ESP)	 REALS231 Handle HB	2					

Items with HB are in the hardware box.

**Denotes Color Code

1

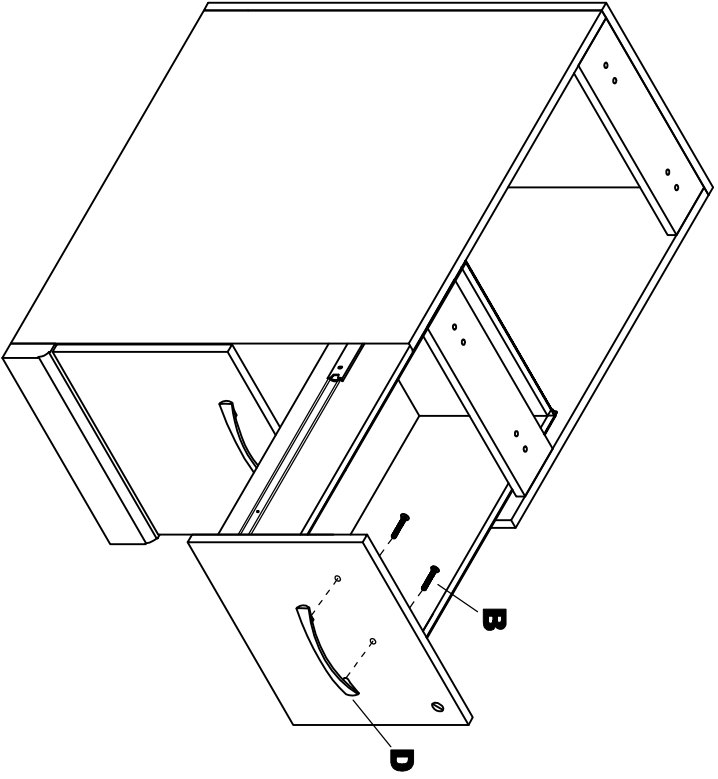

2

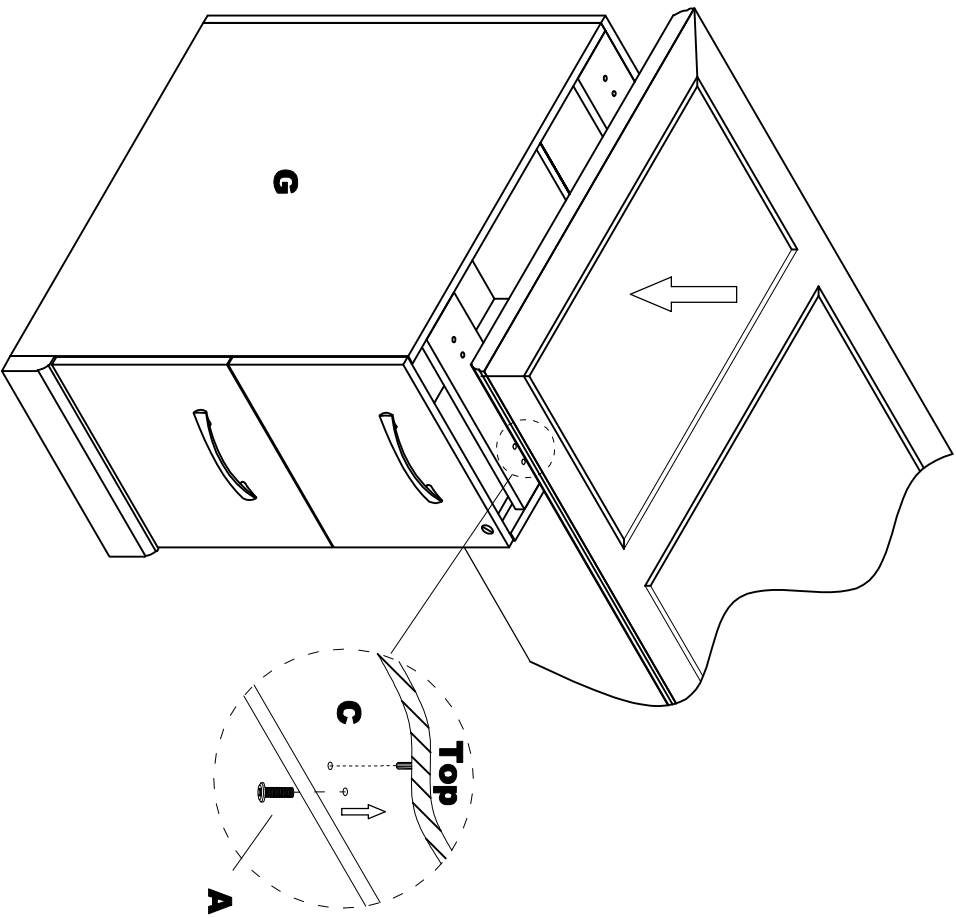

2



3

Real Office Care Instructions

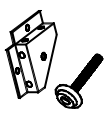
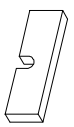
Pre-Assembled Replacement Part List

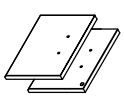
Replacement #	Part	Qty.
REALS057	Drawer Slide 	Pair
REALS008	Leveler w/ Bracket 	1
REALS145	Lock Keeper 	1
TCC0001 (SCR)	Lock w/ keys Black Face 	1
REALS270 (ESP)	Lock w/ keys Silver Face 	1
SFFDF**	Drawer Fronts 	Pair

**Denotes Color Code

Finish Color Matching

Different wood species offer unique texture and grain. Minor variations in finish color, density or shade may occur due to natural characteristics of wood. The term "color match" and consistency are often misleading. The best case achievable using a natural product like wood in a wide variety of lighting conditions is a good "blend" of color and tone throughout the project area. The natural color of the wood product is even altered by the application of a "clear" topcoat finish. The apparent consistency of the color is a combination of light reflectance, cellular structure, natural characteristics, applied colors and sheen - Architectural Woodwork Quality Standards Illustrated, 7th Edition, Version 1.0, 1997, pg. 454

Proper Care of Wood Surfaces

With proper care of the wood surfaces and finishes, your office furniture will provide elegance and convenience for years. Please reference these easy-to-follow guidelines whenever you have a question.

- Clean all surfaces frequently with a soft cloth dampened with warm water, moving the cloth with the grain. **(Do not use furniture polish, solvents or any wax or oil base products.) Never use paper towel.**
- Immediately remove any liquids that come in contact with wood surfaces with a blotting action.
- Lift objects to move them, never pull them across the finished surface.
- Avoid exposure of furniture to extremes of heat and cold, or to wide humidity variances.
- For an additional safeguard, use a protective desk pad. This single item could ensure a lasting finish by protecting your furniture from possible damage caused by pens and sharp objects.
- Do not leave plastic, vinyl or rubber items on finished wood surfaces. Sustained contact may cause deterioration of the finish due to possible chemical reaction between the plastic, vinyl or rubber and the catalyzed lacquer finish.
- If using a protective glass top, place spacer pads under the glass top to allow the wood to breathe.
- Avoid exposure of furniture to strong sunlight. The wood underneath the finish may change color from prolonged exposure to sunlight.
- Avoid exposure of furniture to harsh solvents (nail polish remover, acetates, etc.), as it will cause finish deterioration.

If you have any additional questions please contact our customer service department at 1-800-822-8037

realoffice
by Mayline Group
www.mayline.com