

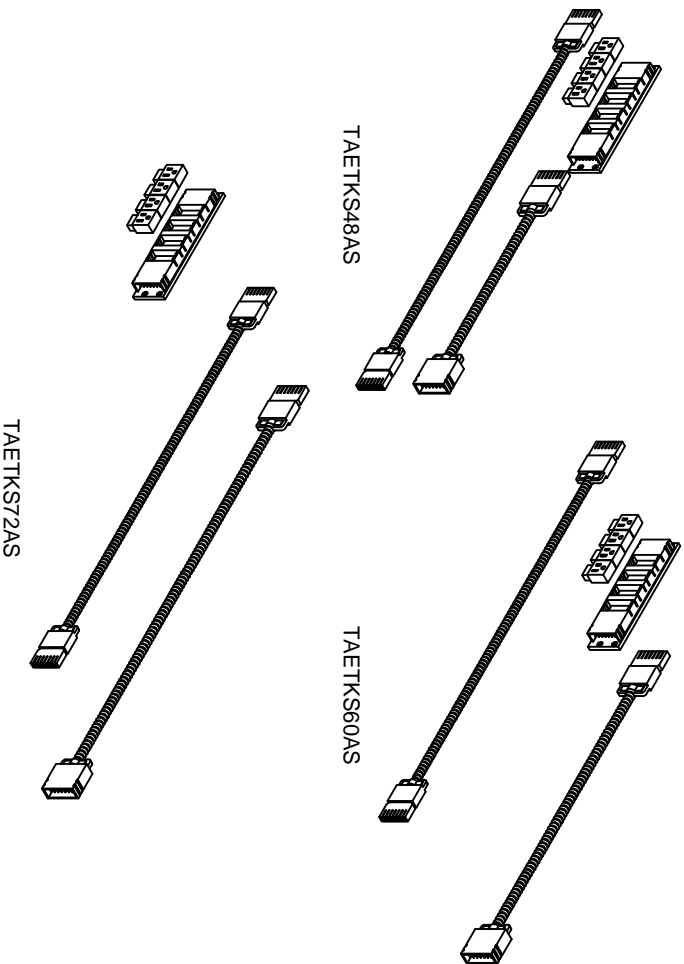

TransAction™

Single Sided Adder Workstation Power

Kits
**TAETKS48AS, TAETKS60AS &
 TAETKS72AS**







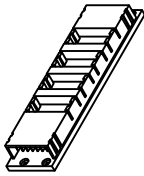

ASSEMBLY INSTRUCTIONS
CALL 1-800-822-8037 FOR ASSISTANCE

P/N **TAETKSAS** 10/13/11

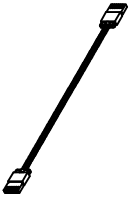
www.mayline.com

PARIS LISI

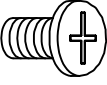
Name	Part	Qty.
A	 Power Block	2
B	 Interconnecting Cable, 3.5" (48" Tables)	1
	 Interconnecting Cable, 16" (60" Tables)	1
	 Interconnecting Cable, 28" (72" Tables)	1

Name	Part	Qty.
C	 Receptacle	8
D	 Screw #8-32 x 3/8	8
E	 Interconnecting Cable, 28"	1

IMPORTANT:
Read all instructions before beginning job. These instructions are provided to avoid problems that may occur from improper assembly. The manufacturer and/or distributor are not responsible for failure resulting from improper assembly or installation. Moreover, all warranties are void for failure to follow these assembly instructions.

1. Snap receptacles (C) into power block (A).

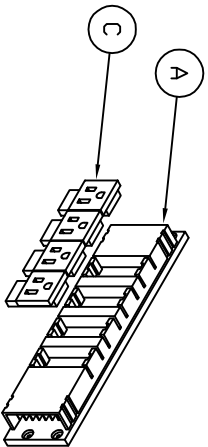

2. Install power block (A) on the inside of the trough side using screws (D).

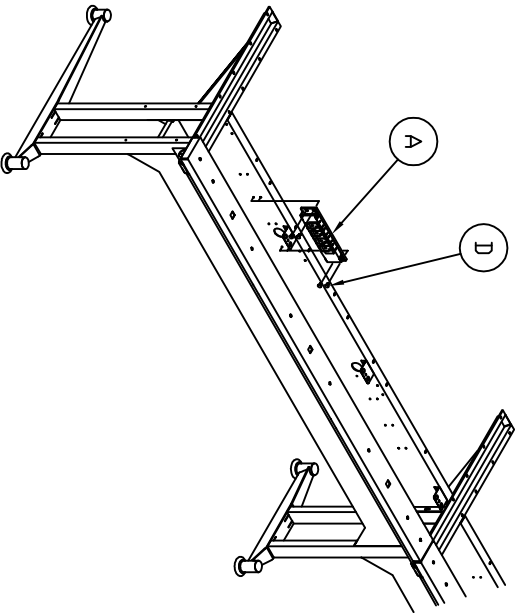

3. Connect power blocks (A) using interconnect cables (B or E).

