

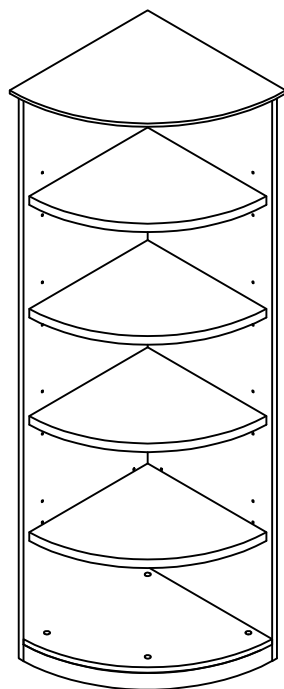

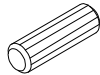





Bookcase, 5 Shelf
Model No. VBQ5

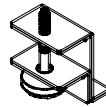

ASSEMBLY INSTRUCTIONS
CALL 1-800-822-8037 FOR ASSISTANCE



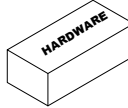

PARTS LIST

Name	Part	Qty.	Spare Qty
A	 REALS004 Wood Dowel	16	1
B	 REALS003 Cam Post	13	2
C	 REALS001 Cam Fastener	13	2
D	 REALS002** Cam Cap	13	2
E	 REALS064 Leveler w/ Bracket	4	

Name	Part	Qty.	Spare Qty
F	 REALS005 4mmx16mm	20	2
H	 REALS065 Shelf Cam	16	1
J	 REALS066 Shelf Cam Post	16	1
	 VBQ5HB		

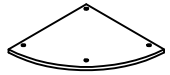
Items with HB are in the Hardware Box
**Denotes Color Code

PARTS LIST

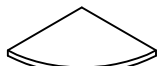
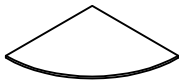
Name	Part	Qty.	Name	Part	Qty.
K	 VBQK** Bottom Shelf	1	N1	 VBQ5N1** Left Side Panel	1
L	 VBQL** Toe Kick	1	N2	 VBQ5N2** Right Side Panel	1
M	 VBQM** Adjustable Shelf	4	P	 VBQP** Top	1

**Denotes Color Code

IMPORTANT!

Review ALL instructions before beginning assembly. These instructions are provided to avoid problems that may occur from improper assembly or installation. Mayline and/or its distributor are not responsible for failure resulting from improper assembly or installation of this product. Moreover, all warranties are void for failure to follow these assembly instructions.

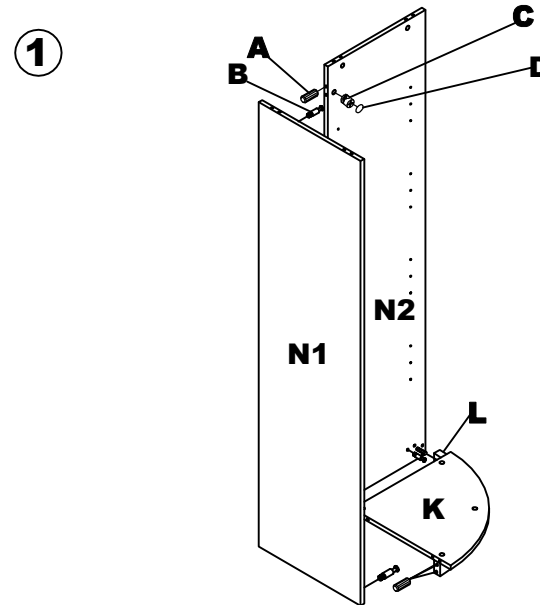

Note: For Step 1, dowels(A) are to be inserted into edge on panel(N2) and bottom(K) and not panel(N1) or inside face of panel(N2) to prevent damage

2

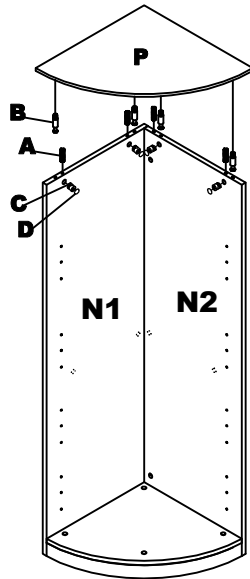

Note: For Step 2, dowels(A) are to be inserted into top edge on panels(N1/N2) and not top (P).

3

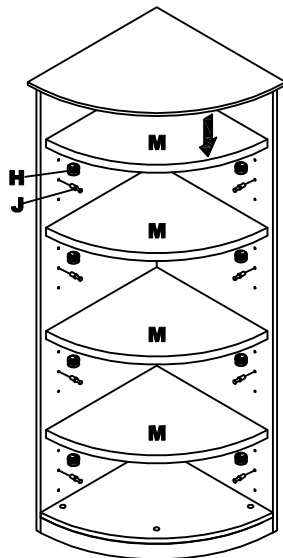

4

4

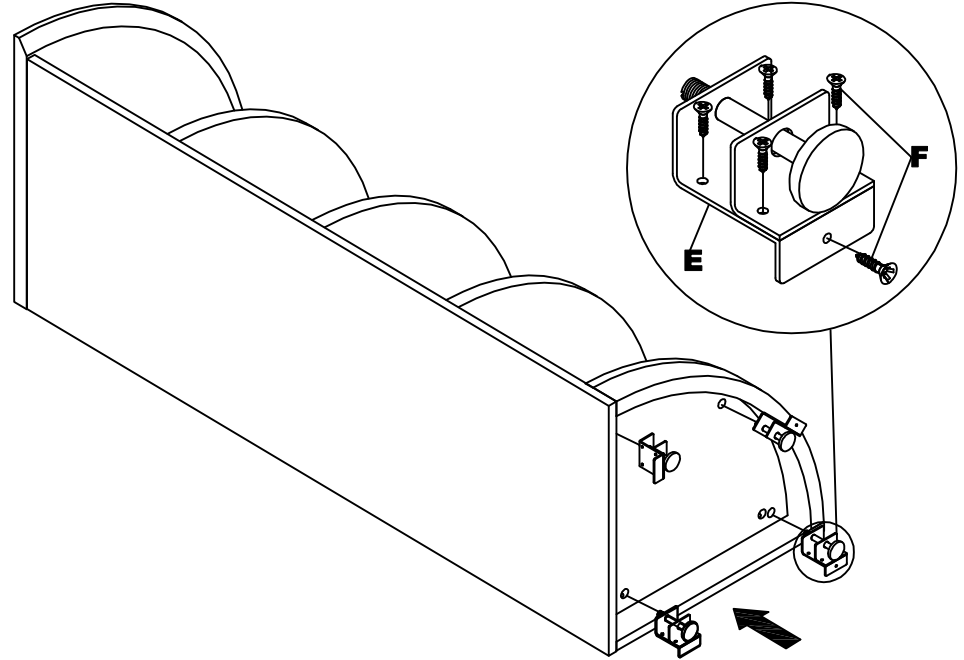

5

Real Office Care Instructions

Finish Color Matching

Different wood species offer unique texture and grain. Minor variations in finish color, density or shade may occur due to natural characteristics of wood. The term "color match" and consistency are often misleading. The best case achievable using a natural product like wood in a wide variety of lighting conditions is a good "blend" of color and tone throughout the project area. The natural color of the wood product is even altered by the application of a "clear" topcoat finish. The apparent consistency of the color is a combination of light reflectance, cellular structure, natural characteristics, applied colors and sheen. - Architectural Woodwork Quality Standards Illustrated, 7th Edition, Version 1.0, 1997, pg. 454

Proper Care of Wood Surfaces

With proper care of the wood surfaces and finishes, your office furniture will provide elegance and convenience for years. Please reference these easy-to-follow guidelines whenever you have a question.

- Clean all surfaces frequently with a soft cloth dampened with warm water, moving the cloth with the grain. **(Do not use furniture polish, solvents or any wax or oil base products.) Never use paper towel.**
- Immediately remove any liquids that come in contact with wood surfaces with a blotting action.
- Lift objects to move them, never pull them across the finished surface.
- Avoid exposure of furniture to extremes of heat and cold, or to wide humidity variances.
- For an additional safeguard, use a protective desk pad. This single item could ensure a lasting finish by protecting your furniture from possible damage caused by pens and sharp objects.
- Do not leave plastic, vinyl or rubber items on finished wood surfaces. Sustained contact may cause deterioration of the finish due to possible chemical reaction between the plastic, vinyl or rubber and the catalyzed lacquer finish.
- If using a protective glass top, place spacer pads under the glass top to allow the wood to breathe.
- Avoid exposure of furniture to strong sunlight. The wood underneath the finish may change color from prolonged exposure to sunlight.
- Avoid exposure of furniture to harsh solvents (nail polish remover, acetates, etc.), as it will cause finish deterioration.

If you have any additional questions please contact our customer service department at 1-800-822-8037

realoffice
www.mayline.com