

ASSEMBLY INSTRUCTIONS

Mercado Wood Guest Chair

Model No. VSC8A

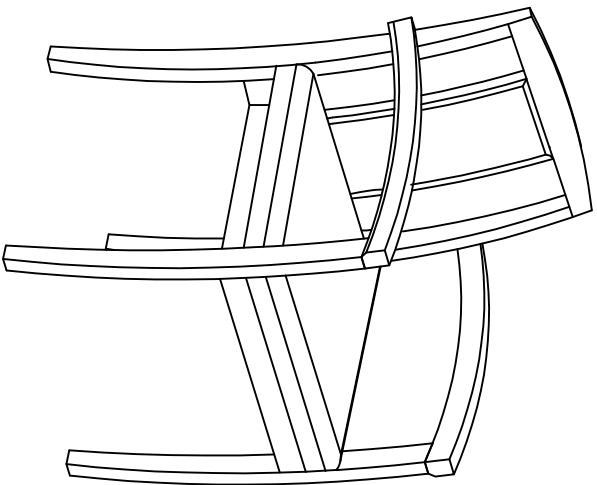

IMPORTANT!
Review ALL instructions before beginning assembly. These instructions are provided to avoid problems that may occur from improper assembly or installation. Mayline and/or its distributor are not responsible for failure resulting from improper assembly or installation of this product. Moreover, all warranties are void for failure to follow these assembly instructions.

P/N VSC8A Revision 02 07/19/2012

MAYLINE
 Mayline Company, LLC
 619 N. Commerce, P.O. Box 728
 Sheboygan, WI 53082-0728
 Toll Free: 1-800-822-8037
 FAX: 920-457-7388
 On Line: www.mayline.com

PARTS LIST VSC8A

When ordering components, specific color and/or size information may be required. Contact a Mayline Customer Service Representative: 1-800-822-8037

* Individual Items. Order by part number.
 ** Denotes Color Code.

Reference Letter	Quantity
A*	1
Part Number 101588** Frame	
Reference Letter	
B*	1
Part Number 101578** Seat	

Part Number	Quantity	Spare
101570* Hardware Bag		
Reference Letter		
C	7	1
Screw M4 x 35mm		

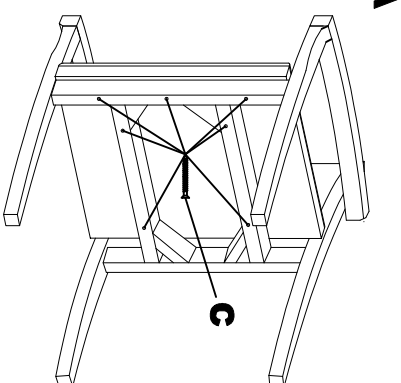
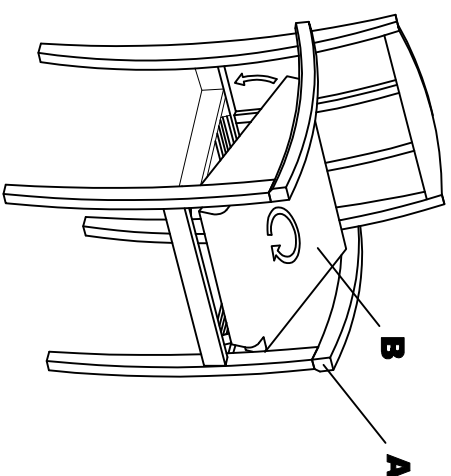

1. Install Seat (B) by rotating into place with front of seat angled down as shown. Gently push seat into place.
2. Attach seat to frame by using Screws (C) 9 places. Apply pressure to the top of seat while attaching screws.

1